

[www.cs-france.fr](http://www.cs-france.fr)

# ACROVYN®

WALL PROTECTION AND HANDRAILS

Protecting your interior

Hospitals, Clinics,  
Nursing homes,  
Kindergartens, Education,  
Transport interchanges  
Hotels, Fitness centres,  
Canteens, Restaurants,  
Retail outlets  
Pharmaceutical and  
Cosmetic industries, etc.

## Company introduction

What a long way the C/S Group has come since launching C/S Acrovyn® in the early seventies!

Here are some examples of major changes:

- New colours (originally 4, currently 30)
- Change in shapes (formerly with angles, now soft)
- A larger number of models to meet all building configurations.
- And now a broad choice of materials responding to environmental and sustainable needs

All these improvements, which have resulted from listening to our customers, have enhanced the C/S Group's unquestionable position as world leader.

Philippe Luguët  
Manager



Aerial view of C/S France's factory  
at Pacy-sur-Eure



# The world of architectural protection

## WALL PROTECTION AND HANDRAILS

safety

architecture

beauty

fresco

fluidity

material

hygiene

environment

geometry

design

adaptability

comfort

ergonomics

light

colour

mobility

signposting

layout

art

fire resistance

space

decoration

Our mission :

Wall protection combined with leading-edge design

## ACRO CONCEPT™

- The concept of architectural protection Page 6
- Product ranges Page 8
- C/S Acrovyn® formulation Page 10
- Ergonomic shapes Page 12
- Colours, finishes and materials Page 14
- C/S Acrovyn® 3000: protect the environment Page 16

## ACRO SPACE™

- Open spaces and circulation areas Page 20
- Corridors Page 22
- Emergencies Page 24
- Hospital wards Page 26
- Operating theatres Page 28
- Reception area Page 30
- Lifts / Staircases Page 32
- Cultural centres Page 34
- Fitness centres Page 36
- Education Page 38
- Catering Page 40
- Restaurants Page 42
- Industrial laboratories Page 44
- Retail outlets Page 46
- Hotels Page 48
- Loading bays / logistical centres Page 50
- Transport interchanges Page 52

## ACRO ITEMS™

- C/S Acrovyn® Sheet (flat surface protection for doors and walls) Page 58
- C/S Acrovyn® Handrails Page 68
- C/S Acrovyn® Bumper guards Page 70
- C/S Acrovyn® Corner guards Page 73
- C/S Stelatex® Page 74

## ACRO SERVICES™

- Our services Page 76



# ACRO CONCEPT™

Products that meet all your requirements

C/S Acrovyn® protects interiors and ensures durability.

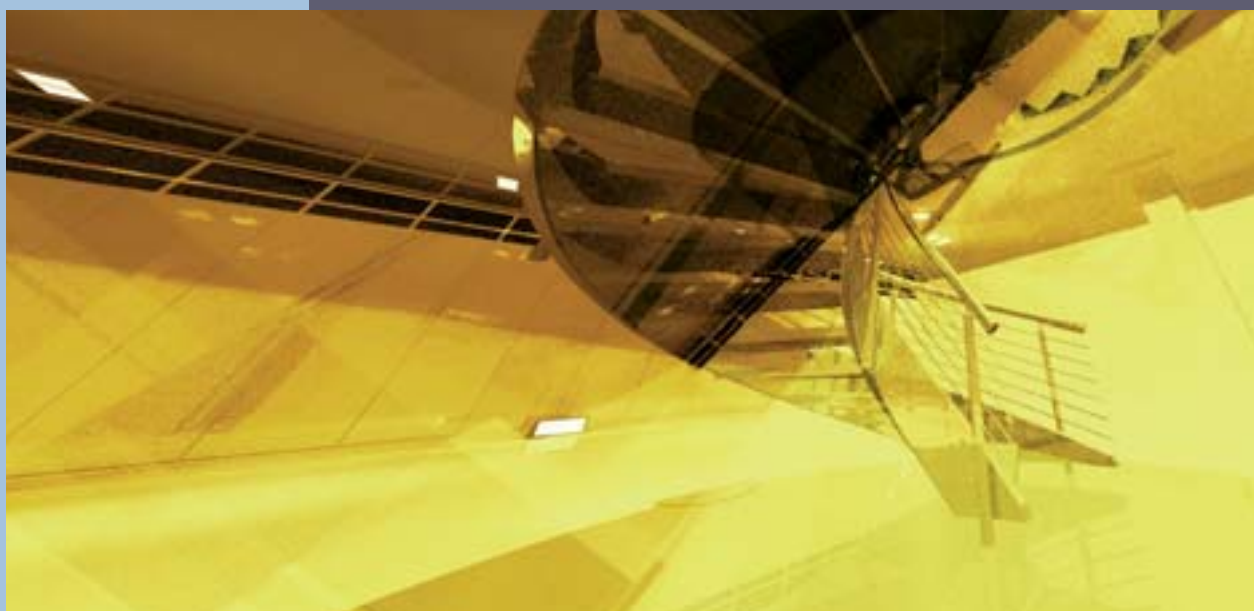

## The Acrovyn® concept: wall protection for public buildings.

- The movement of people and equipment causes damage to internal surfaces. Designers and end users are constantly concerned with hygiene and maintenance of the interior.
- Our wall protection concept meets these expectations. C/S Acrovyn® products protect walls, corners, doors and facilitate maintenance. C/S Acrovyn® helps to keep the building in its original condition and allows you to reduce maintenance costs.
- C/S Acrovyn® handrails provide support with enhanced comfort and safety.

With both our techniques and know-how, C/S Acrovyn® handrails provide protection and design to public facilities:

- All types of public buildings that are subject to impact damage.
- All types of buildings where hygiene and maintenance is a priority.
- All types of buildings requiring mobility aids.

Hospitals • Clinics • Nursing homes • Kindergartens • Education • Canteens  
Restaurants • Hotels • Airports • Libraries • Shopping Centres • Fitness centres  
Swimming Pools • Retail outlets • Pharmaceutical and Cosmetic Industries

## What we provide...

**TO THE CLIENT:**

- Permanent solutions
- Reduction of maintenance costs
- Hygiene
- Safety

**TO THE MAIN CONTRACTOR:**

- Architectural project
- Design
- Technical solution
- Expertise



Working  
in partnership  
with the owner  
and design  
team.

**TO THE INSTALLER:**

- Quick and easy installation
- Savings
- Instructions and accessories
- On-site technical assistance

**TO THE USER:**

- Pleasant living / working environment
- Safety
- Ergonomic comfort
- Hygiene
- Aesthetics

**TO CONTROL BODIES:**

- Compliance with safety, hygiene and environmental standards
- Certification reports



The product ranges:

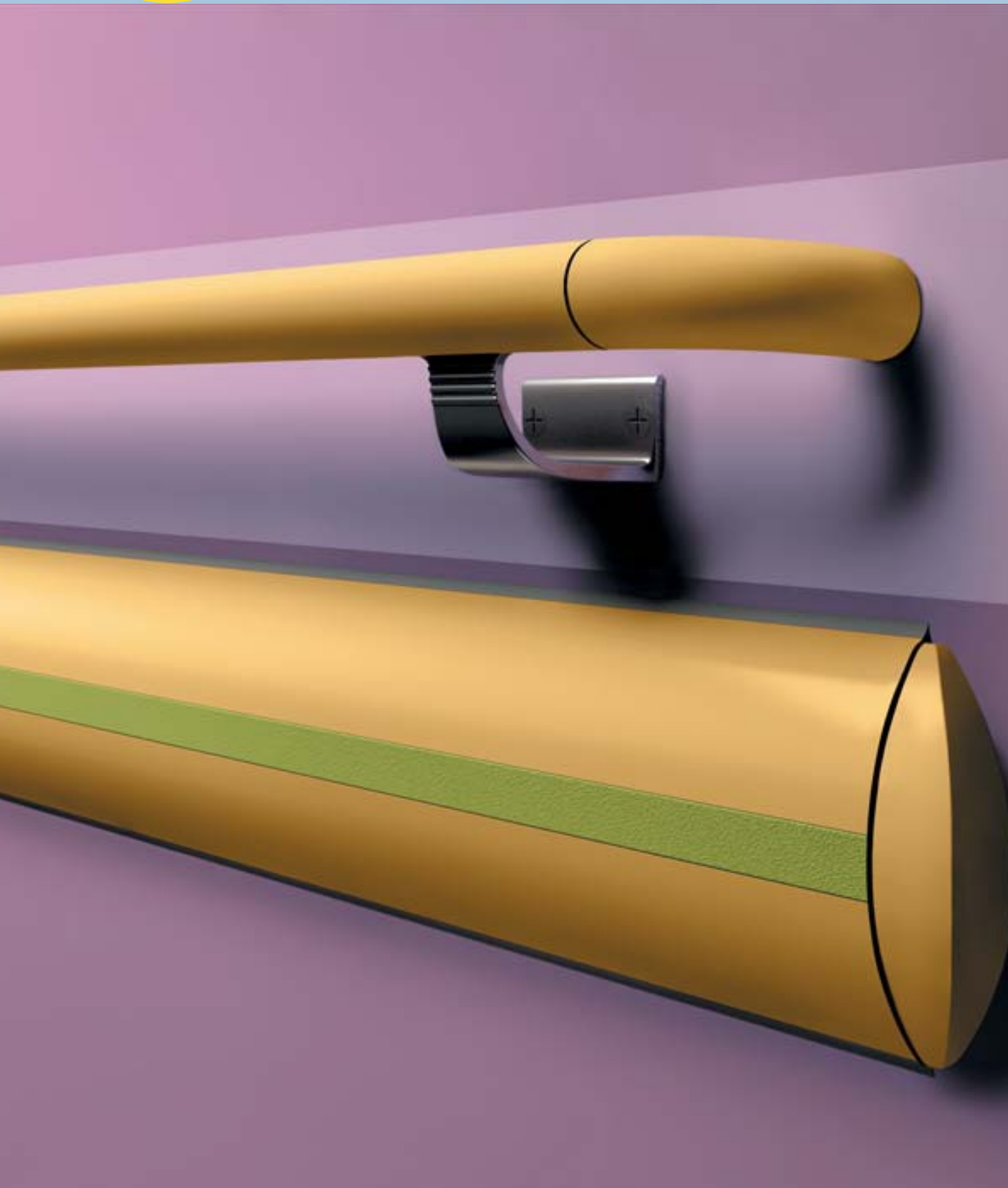

## Product ranges for wall protection and mobility aid

### ■ C/S Acrovyn® sheets

A complete or mid-wall covering that combines design and protection:

- For application on walls and doors
- Creative freedom
  - Standard shapes offered by C/S
  - Custom design and shapes

### ■ C/S Handrails

Handrails used as mobility aids in corridors and staircases.

### ■ C/S Crash rails

Bumper guards positioned at required impact level

### ■ C/S Corner guards

Protection to cover exposed wall corners.

## Proven formulation



**In the early 70s, the C/S Group's founder developed the Acrovyn® resin and an innovative wall protection concept.**

Acrovyn® is a special formulation based on a vinyl acrylic resin including shock modifiers, fire retardants and UV stabilizers.

Aware of the immense potential, the Company then developed varied shapes and colours as a solution to internal protection problems.

It was a rapid success, particularly in the healthcare sector.

Over recent years, the products developed have been used in various types of buildings.

C/S France carries on its research to create new materials, new products and new colours in order to meet new needs.



## ENVIRONMENTAL APPROACH

Aware of the ecological and health concerns, C/S France has decided to apply the European directive 2002/95/CE or RoHS to the C/S Acrovyn® range. This directive limits the use of toxic materials such as lead. Although it only applies to electrical and electronic equipment, we have found it essential to anticipate the impact on our market for the well-being of users and, more generally, for our environment. We have decided to be the forerunners.

## C/S Acrovyn® : technical characteristics

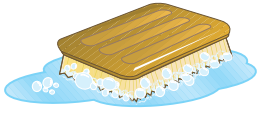

### DISINFECTION AND CLEANING TEST CARRIED OUT BY LOUIS PASTEUR INSTITUTE IN STRASBOURG

The C/S Acrovyn® material is non porous so that its smooth or light textured surface makes cleaning operations easy and effective.

#### Tests show it:

We carried out a study of the cleaning action of disinfectant cleaners used in hospitals on C/S Acrovyn® surfaces. The report prepared by the Institute of Hygiene and Preventive Medicine of University Louis Pasteur in Strasbourg (recognised and independent body) has shown that all our products can be easily cleaned.

### CHEMICAL RESISTANCE

C/S Acrovyn® resists most diluted acids, alkalis and salt solutions, mineral or vegetable oils, betadines, alcohols, White Spirit, fatty acids and others.

The complete table of chemical resistance is available upon request.



**FIRE RESISTANCE :** Euroclasse certification EN 13501-N (Euroclasse EN 13501-EN with test result B – s2 – d0)

C/S Acrovyn® is characterised by low flammability. It is self-extinguishing when the flame is moved away.

The reports of the tests carried out by the French LNE laboratory are available upon request.

### MECHANICAL PROPERTIES

C/S Acrovyn® provides outstanding impact and scratch resistance.

The tests, carried out in standard conditions of use, showed that the tested products had suffered no damage after being hit by a load of 250 kg projected at a speed of 5 km/h.



### MATERIAL RECYCLING

All products in the C/S Acrovyn® range can be recycled in the industry.

### UV STABILITY

The C/S Acrovyn® resin provides perfect stability to UV indoors.



# The ergonomic shapes:





We have created several product shapes to suit the different building designs.

- A C/S ACROVYN® SHEET**  
(flat surface protection for doors and walls)  
Sheets cut and thermoformed as required to allow freedom of your imagination.
- B SHAPE OF NOW**  
Streamlined shapes ideal for modern architecture.
- C TRADITIONAL**  
Simple geometric shapes to match traditional environments.
- D HYGIENIC**  
Varied shapes, with a smooth finish, specially created for locations where hygiene is a priority.
- E C/S STELATEX®**  
High-resistant elastomers with simplified shapes.

# The colours, finishes and materials:



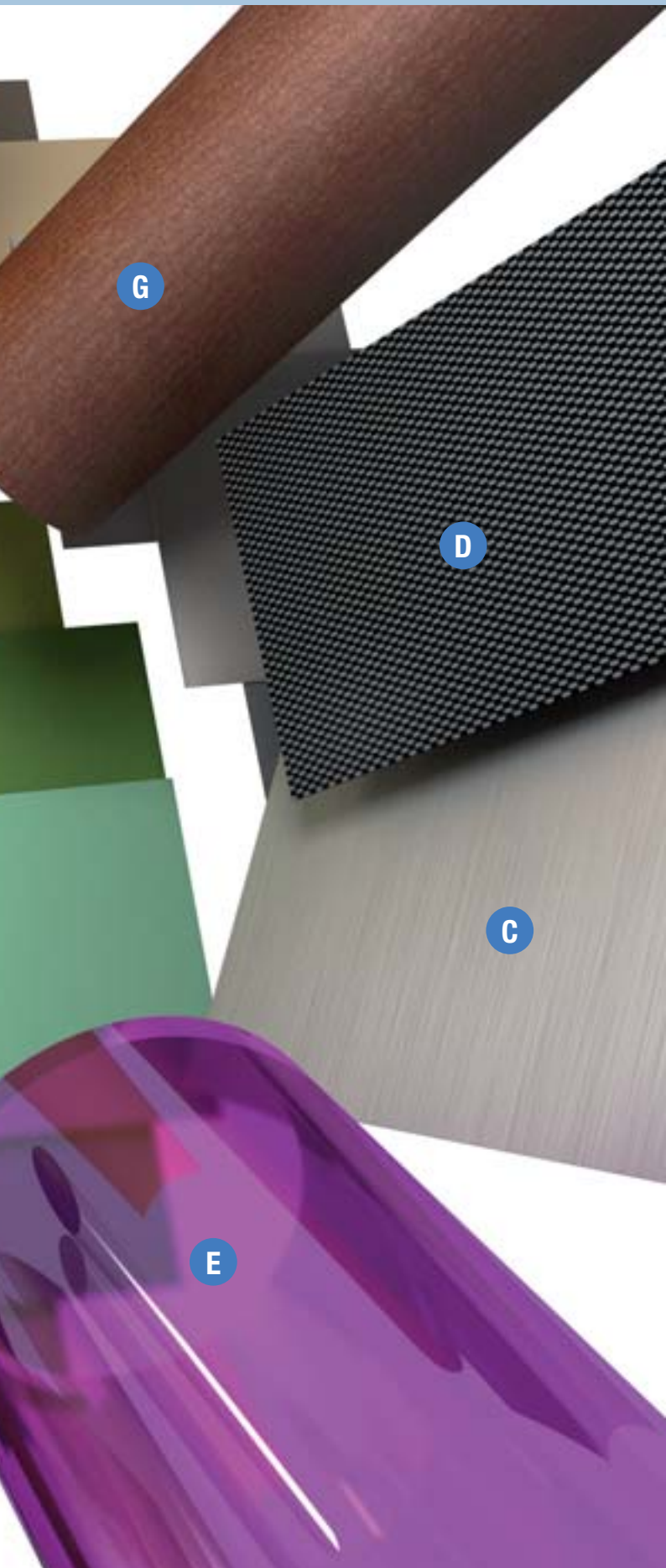

## C/S Acrovyn®:

### A C/S Acrovyn® Colour Range

Our designers have defined a range of 30 Standard Solid colours to match floor, wall and door coverings.



C/S Acrovyn®  
Solid Standard  
Colours

### B C/S Acrovyn® Faux Wood

Enjoy the warmth of wood combined with the advantages of C/S Acrovyn®. 5 woodgrains available:

- Arctic Birch
- Classic Maple
- Classic Beech
- Amber Cherry
- Cherry



C/S Acrovyn®  
Faux Wood

### C C/S Acrovyn® Faux Brushed Silver

The appeal of metal with C/S Acrovyn® properties.



C/S Acrovyn®  
Faux Brushed  
Silver

### D C/S Acrovyn® Faux Carbon

A revolutionary, futuristic design



C/S Acrovyn®  
Faux Carbon

## Other materials :

### E Vision

A translucent, coloured handrail. A C/S France unique product. 5 exciting colours.

### F Metal

- Stainless steel
- Aluminium



Brushed  
stainless  
steel



Silver  
anodized

### G Wood

- Beech



Wood  
Beech

### H C/S Acrovyn® 3000

New generation C/S Acrovyn® offering higher impact resistance, whilst protecting the environment. 8 colours.



C/S Acrovyn® 3000  
8 colours



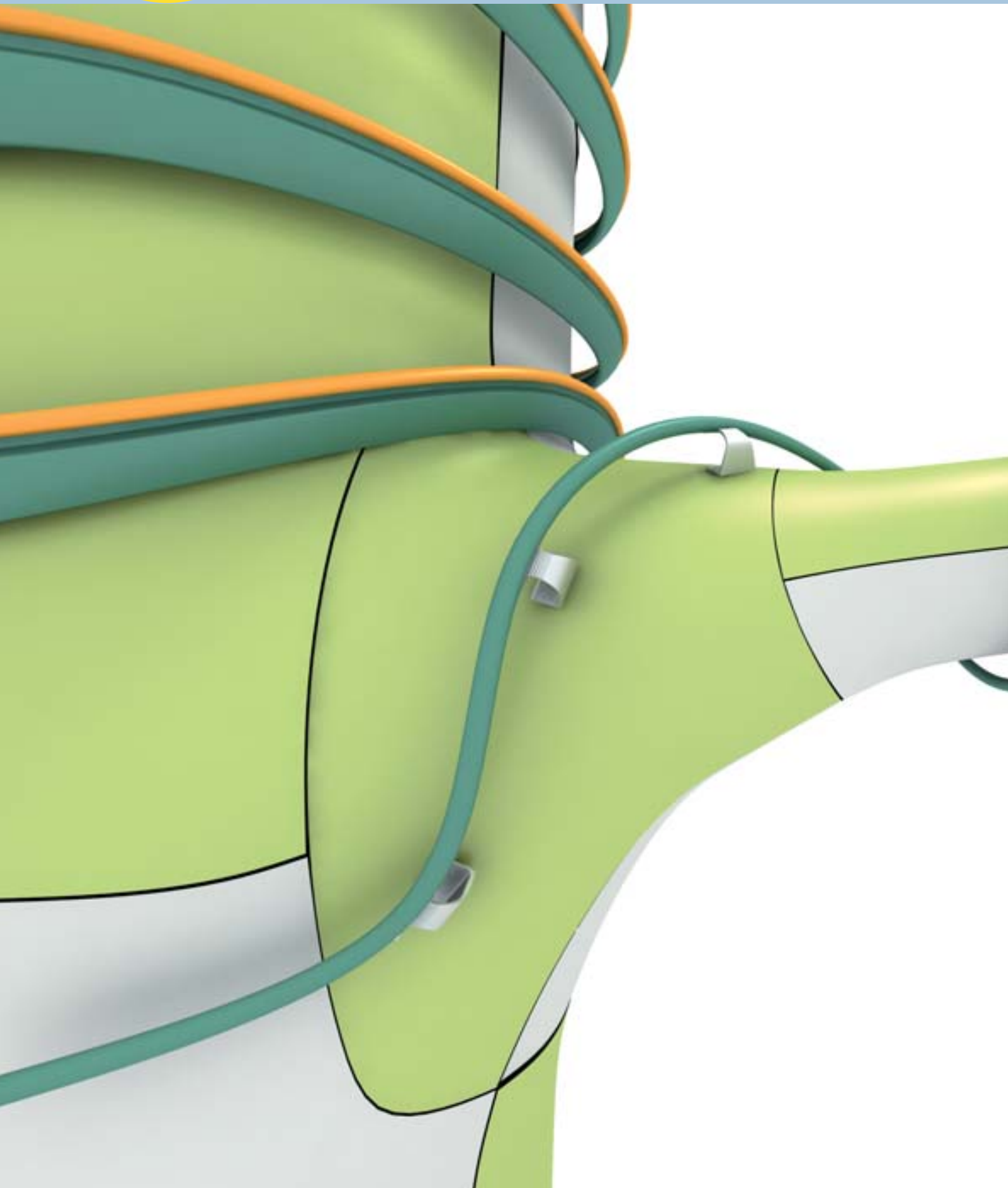

## C/S Acrovyn® 3000



**C/S Acrovyn® 3000**  
**8 colours**



Beyond the performance proven by standard Acrovyn® for over 40 years, C/S France, in its HQE approach, has developed C/S Acrovyn® 3000.

C/S Acrovyn® 3000 benefits exclusively from F2 classification, which describes the opacity and nature of the smoke released.

C/S Acrovyn® 3000 further enhances standard Acrovyn's legendary resistance to impact, whilst preserving its unrivalled design (shapes, textures, colours, etc.).



**Fire certification**



**Smoke certification**



# ACRO SPACE™

Interior fit-out solutions

C/S Acrovyn® ideally fits into your interiors.  
Our choices of colours, materials and shapes are part of an  
innovative approach that aims to put design at the forefront.





E

B

A

F

# Circulation areas

Circulation areas are exposed to impact and damage; with C/S Acrovyn<sup>®</sup>, they will stand the test of time.



**C/S Acrovyn<sup>®</sup> sheet  
Rectangular and  
Half-Moon Shape**

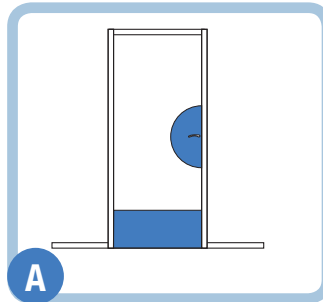

**A**

**Tubular handrail  
MCE 40/45**

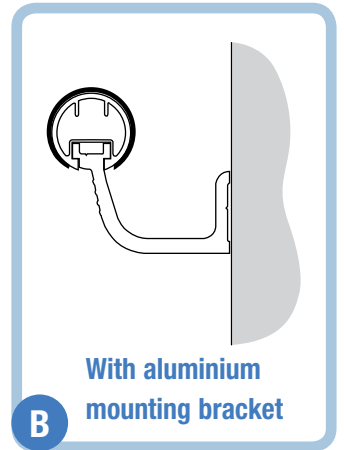

**B**

**Tubular handrail  
MCE 40/45**

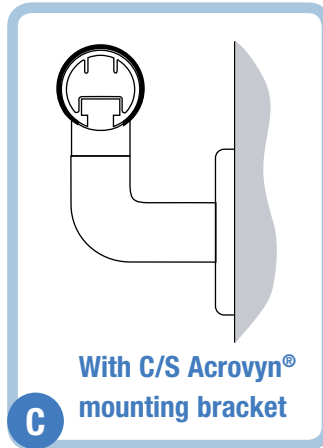

**C**

**Trolley Plate  
TP 150**

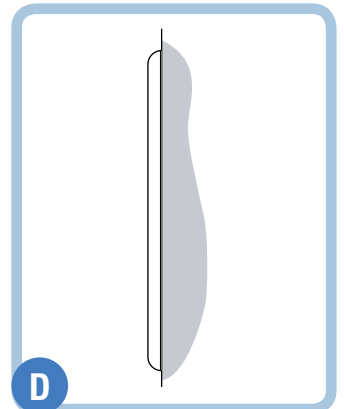

**D**

**Stick-On Corner guard  
SO 50**

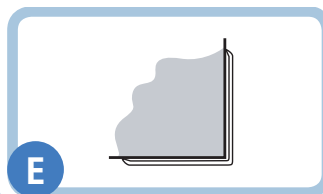

**E**

**Variable Angle Stick-On  
Corner guard  
SO 50 V**

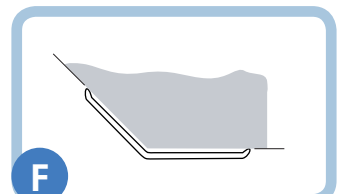

**F**

0 to 94 →  
5 to 100

83



82

B

C

A

E

# Corridors

Decorative wall protection enhancing your interior.



**C/S Acrovyn® sheet  
Half-moon Shape**

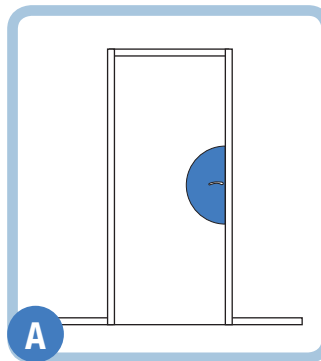

**Handrail  
HRB 35**

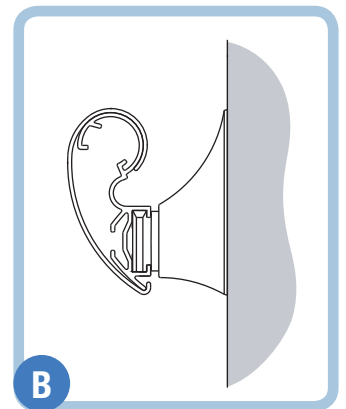

**Trolley Plate  
TP 300**

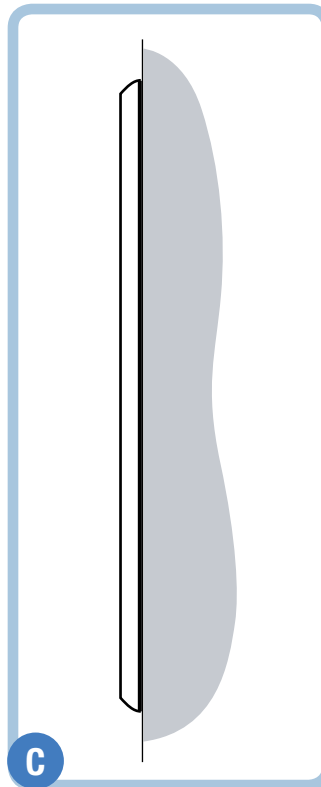

**Stick On Corner guard  
SO 75**

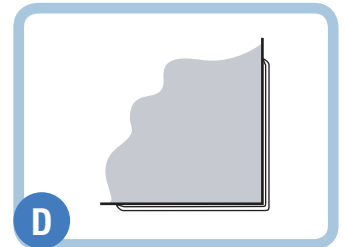

**Variable Angle Stick-On  
Corner guard  
SO 50 V**

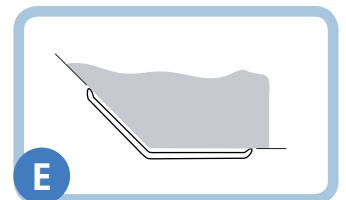





EMERGENCIES

D

B

C

A

# Emergencies



**C/S Acrovyn® 3000**  
**8 colours**

Emergency services are subject to intense activity; C/S Acrovyn® 3000 is the ideal solution for heavy duty impact resistance.

**C/S Acrovyn® sheet**  
**Dune Shape**

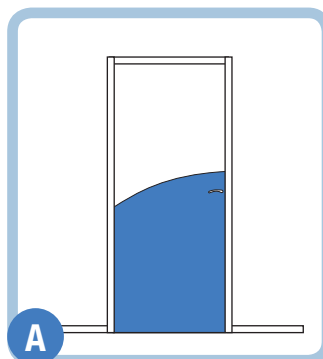

**Handrail/Bumper guard**  
**HRB 20 Duo**

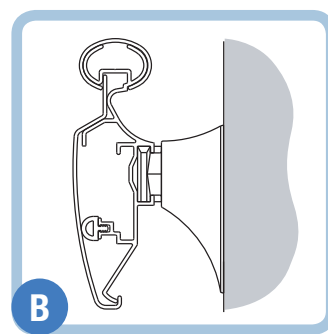

**Crash rail**  
**SCR 80M**

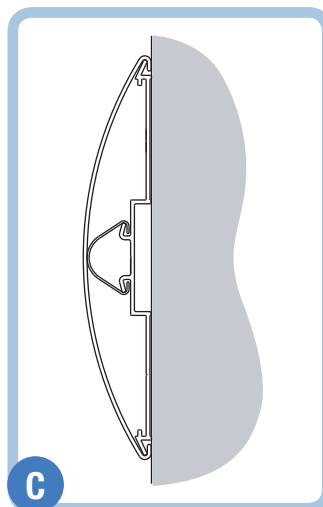

**Surface Mounted**  
**Corner guard**  
**SSM 20**

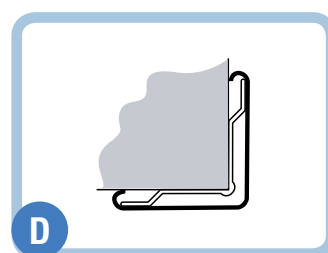



# Hospital wards



**DuoColour**  
2x5 combinations

Our products create a comfortable, bright and warm atmosphere.



**C/S Acrovyn® sheet  
Bed Head  
protection**

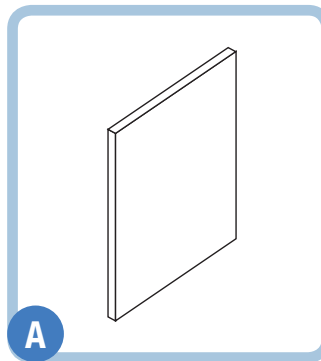

**C/S Acrovyn® sheet  
Valley Shape**

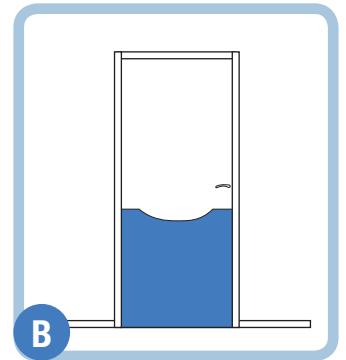

**Trolley Plate  
TP 200 Duo**

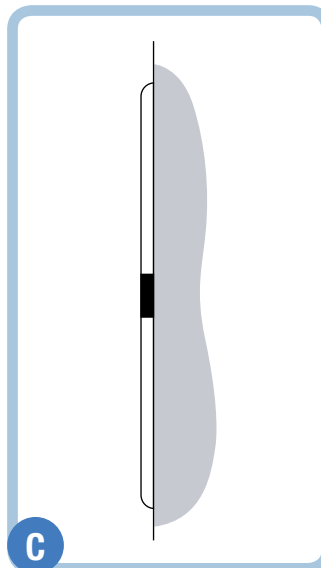

**Variable Angle Stick-On  
Corner guard  
SO 50 V Duo**

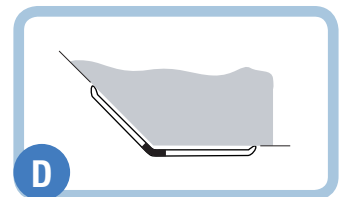



# Operating theatre

Hygiene is a constant concern; you need full height wall coverings that are easy to clean. C/S Acrovyn® sheet for door and wall protection will meet your requirements.



C/S Acrovyn® smooth sheet  
Wall

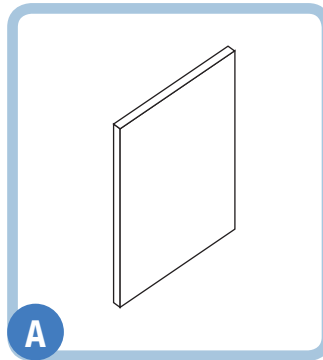

C/S Acrovyn® sheet  
Thermoformed external  
angle 135° with welded  
joint to the adjacent  
sheet

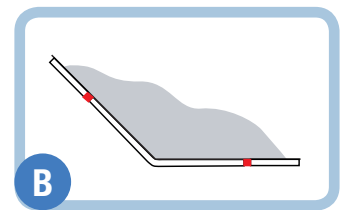

C/S Acrovyn® sheet  
Thermoformed internal  
angle 90° with welded  
joint to the adjacent  
sheet

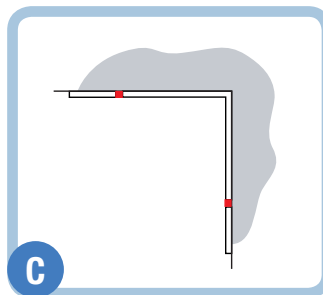

C/S Acrovyn® sheet  
Welded joint

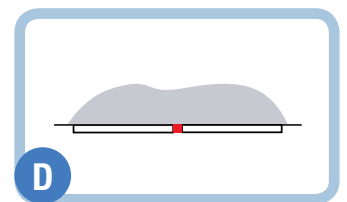



# Reception area



Functional and good-looking, the reception reflects the image of your premises. C/S Acrovyn® both protects and enhances this busy area.

**Handrail/Bumper guard  
HRB 4C**

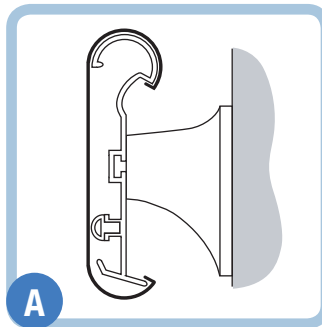

**Feature Rail  
FR 225**

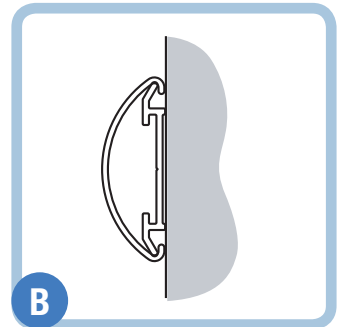

**Crash Rail  
SCR 50M**

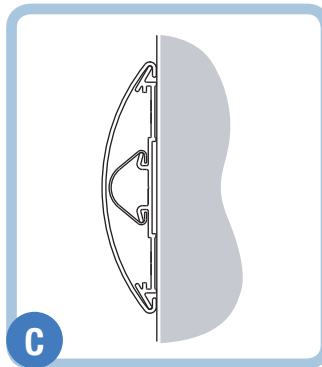

**Stick-On Corner guard  
SO 30**

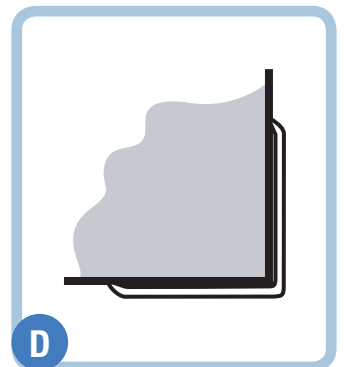

**Cove Base  
CB 100**

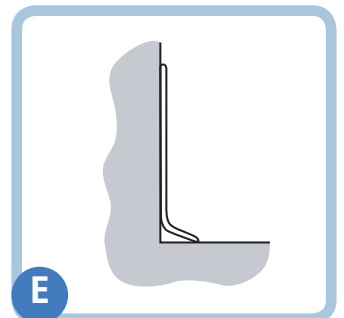





# Lift / Staircase

These circulation areas are subject to heavy traffic, C/S Acrovyn® is a major benefit.

D

C/S Acrovyn® sheet  
C/S Acrovyn® Faux  
Brushed Silver

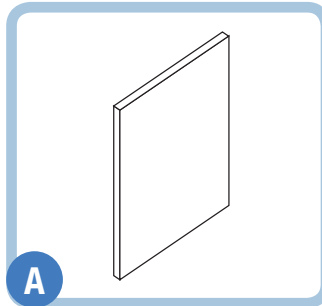

A

Handrail/Bumper guard  
HRB 35 A Aluminium

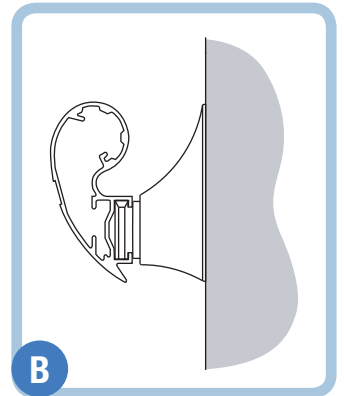

B

Tubular handrail  
MCE 40/45 A Aluminium

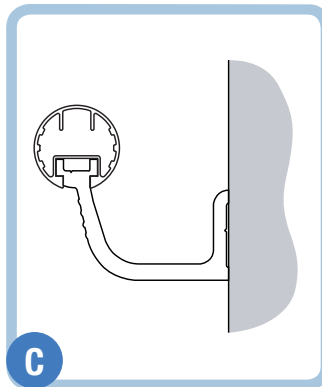

C

Surface Mounted  
Corner guard  
SSM 20  
C/S Acrovyn® Faux  
Brushed Silver

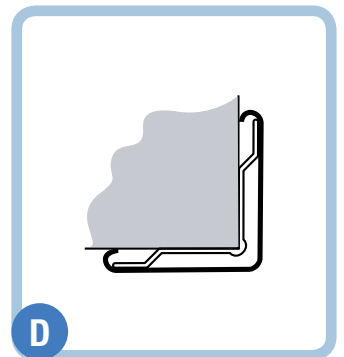

D

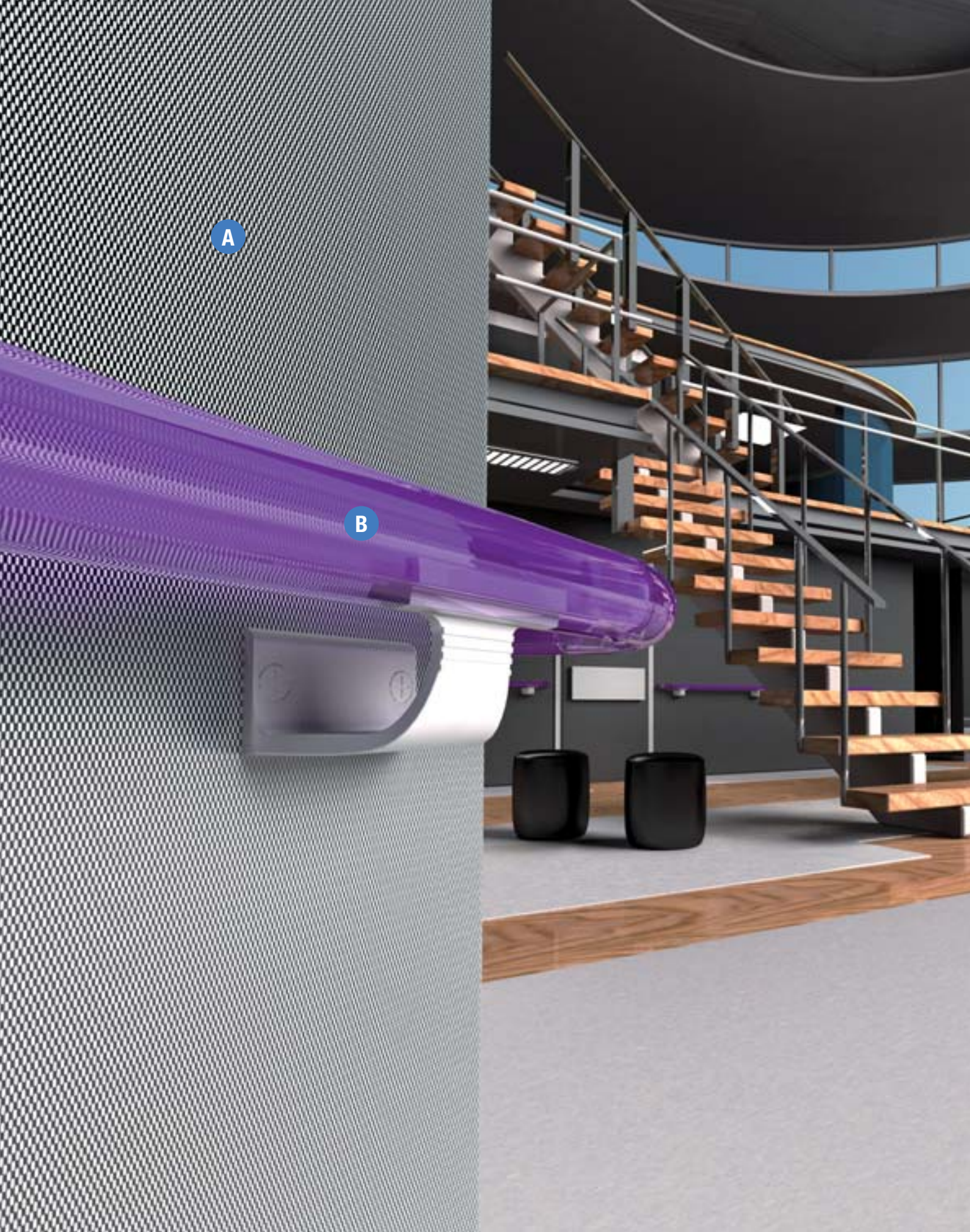

# Cultural centre

Need for stylish protection.  
Our products perfectly fit into  
the architecture of cultural  
facilities for the pleasure  
and comfort of users.

**C/S Acrovyn® sheet**  
**C/S Acrovyn® sheet**  
**Faux Carbon**

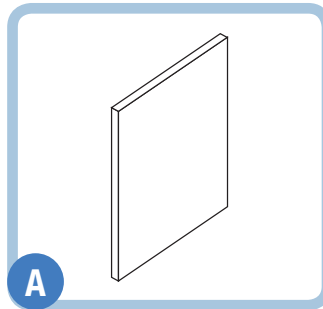

**Tubular handrail**  
**Vision**

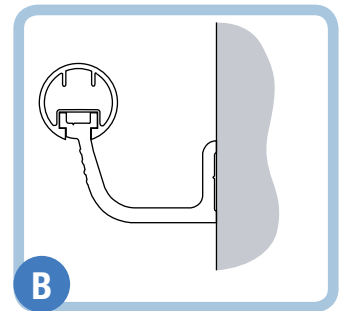



# Fitness centres

The warmth of wood strengthens the feeling of well-being in your facilities.

C/S Acrovyn® sheet  
C/S Acrovyn® Faux  
Wood

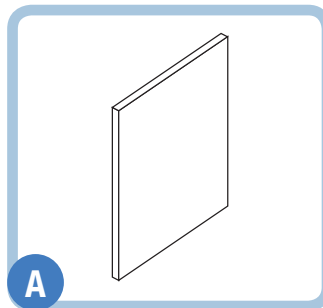

C/S Acrovyn® sheet  
door protection  
C/S Acrovyn® Faux  
Wood Oasis Shape

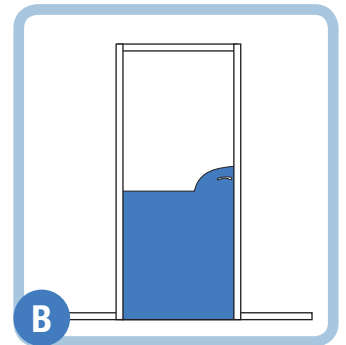

Tubular solid Wood handrail  
MCW 40/45 Beech

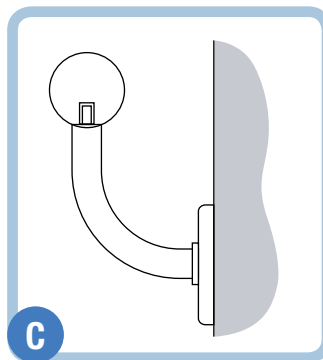



canteen →

Thursday

C

B

D

# Education

C/S Acrovyn® products help to create an inviting, child-friendly environment which stimulates learning.



A

CE1

C/S Acrovyn® sheet  
Textured

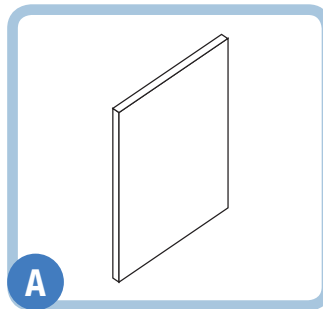

A

C/S Acrovyn® sheet  
Fresque

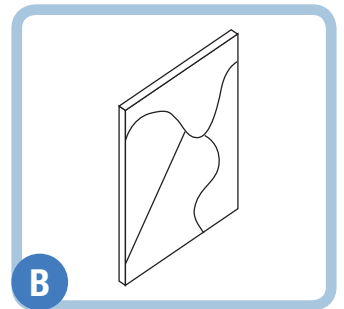

B

Tubular handrail  
Vision

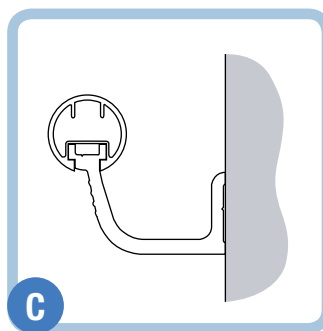

C

Stick-On Corner guard  
SO 30

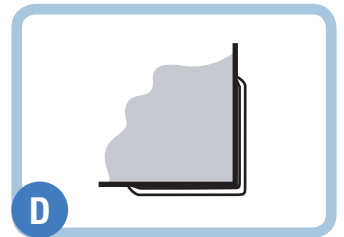

D





# Catering

Resistant and easy to clean, our products meet the high impact resistance and hygienic requirements in catering facilities.

**C/S Acrovyn® sheet  
Smooth**

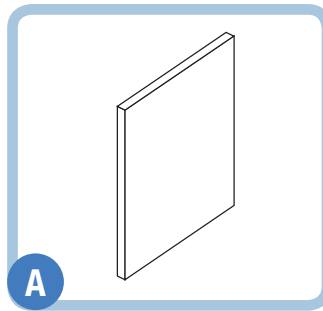

**Stainless steel crash rail  
CRS 200**

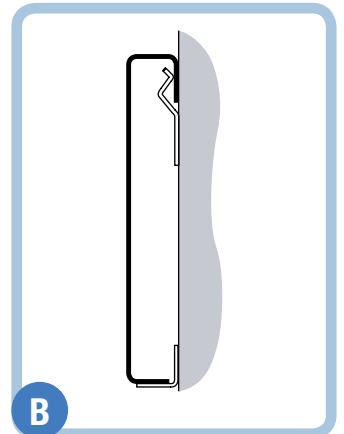

**Smooth Crash rail  
Aronde 170 Duo**

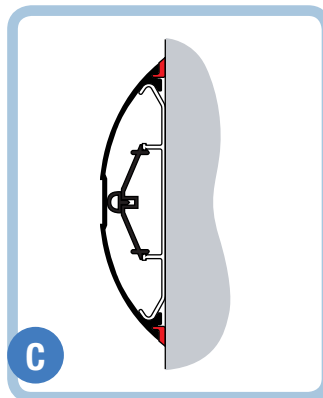

**Stainless steel  
Corner guard  
50A**

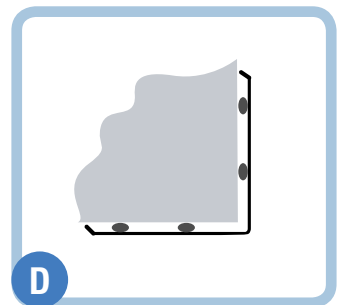

C



A

B

C

D

# Restaurant



**C/S Acrovyn®  
Faux Wood**

For a convivial, welcoming and warm dining room, C/S Acrovyn® Faux Wood is the ideal solution, which provides design options and durability. Our C/S Acrovyn® interior wall protection creates your personal design and ensures long term protection.

**C/S Acrovyn® sheet  
C/S Acrovyn® Faux  
Wood**

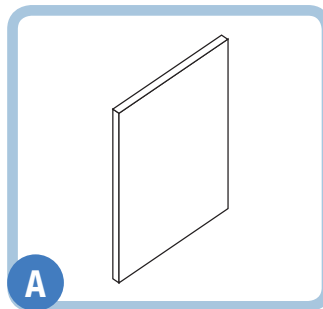

**A**

**Tubular handrail  
HR 06**

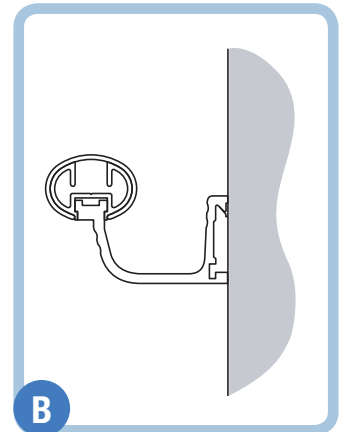

**B**

**Crash rail  
SCR 80M**

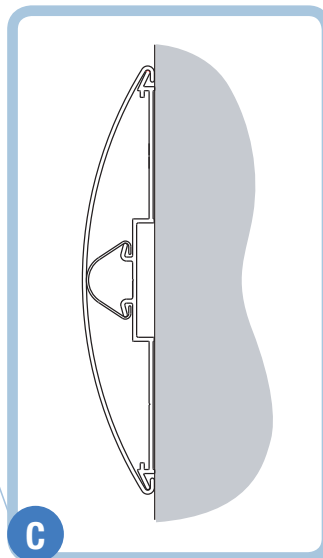

**C**

**Surface Mounted  
Corner guard  
SSM 20**

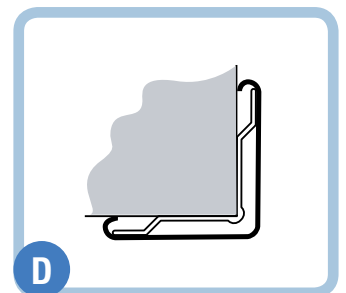

**D**



A

D

# Industrial laboratory

C/S Acrovyn® meets all requirements such as safety and hygiene in a simple and pleasant style.

C/S Acrovyn® sheet  
**Smooth**

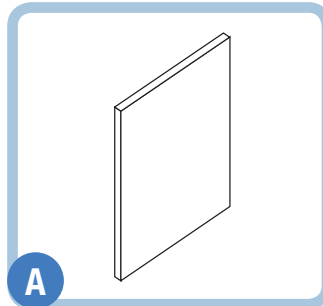

Full aluminium  
Bumper handrail  
**ECR 32 A**

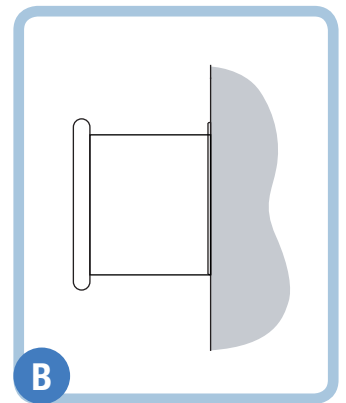

Smooth Crash rail  
**Aronde 170**

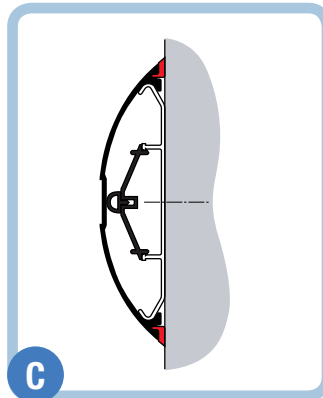

Surface Mounted  
Corner guard  
**SSM 20**  
C/S Acrovyn® Faux Brushed  
Silver

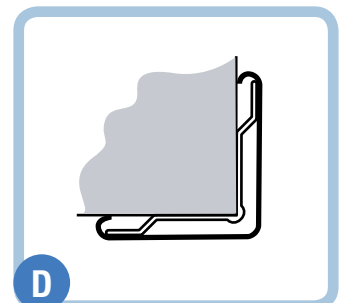

SERVICE



A

D

B

# Retail outlets

Streamlined and efficient, our protection products harmoniously fit into all your sales areas.

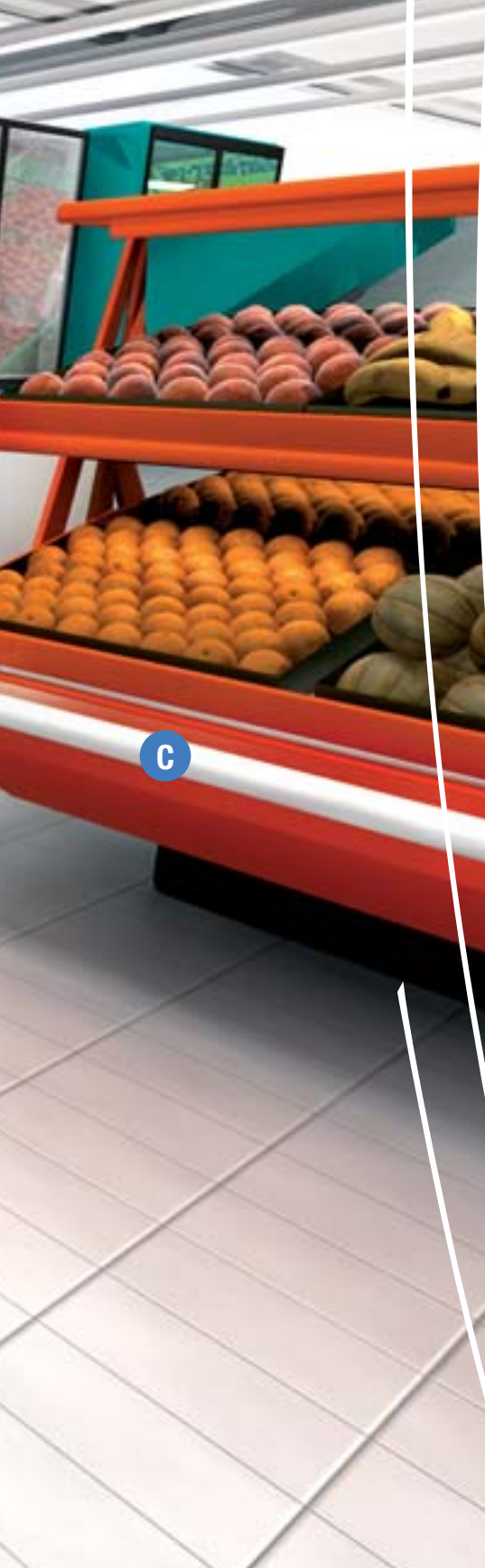

**Handrail/Bumper guard  
ECR 32 A**

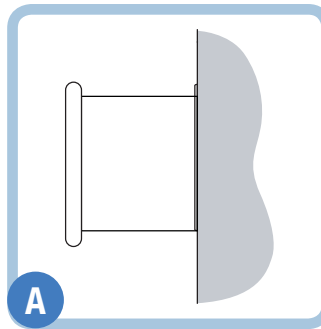

**Low Level Rail  
Stainless steel  
LLR-SS**

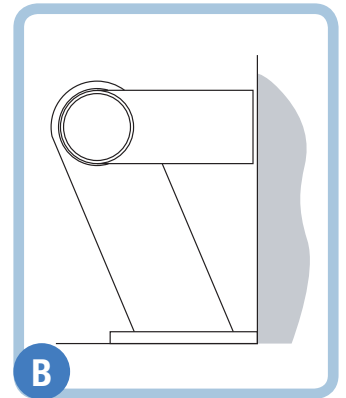

**Feature Rail  
FR 225**

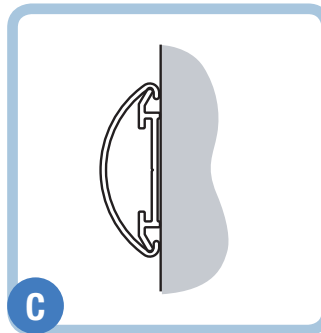

**Surface Mounted  
Corner guard  
SM 20**

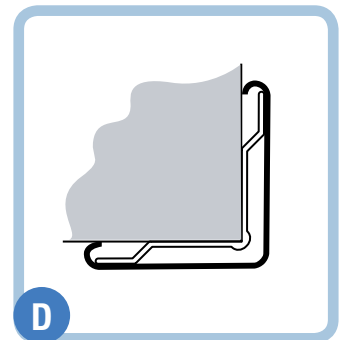





D

B

A

# Hotel

We propose to customize your style for the pleasure and satisfaction of your customers.

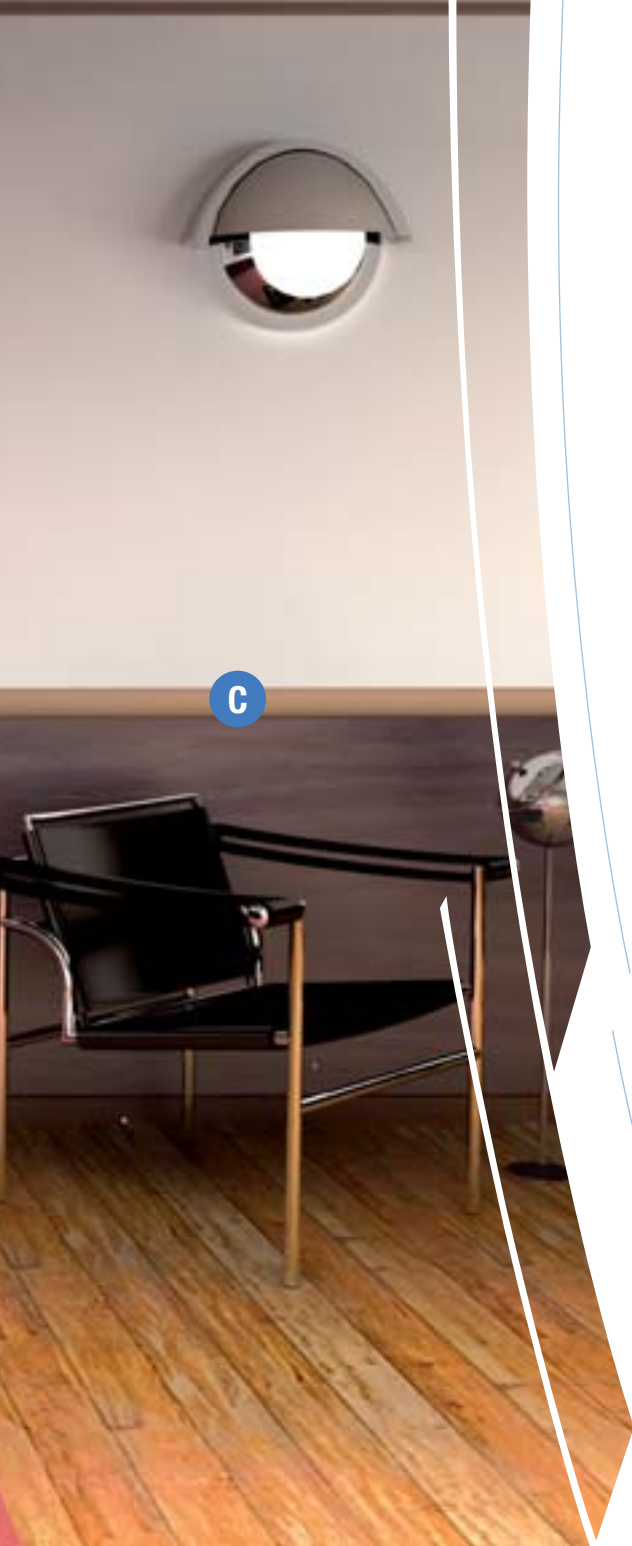

C

C/S Acrovyn® sheet  
C/S Acrovyn® Faux  
Wood

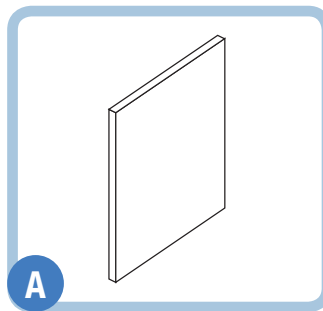

A

C/S Acrovyn® sheet  
Customized door  
protection

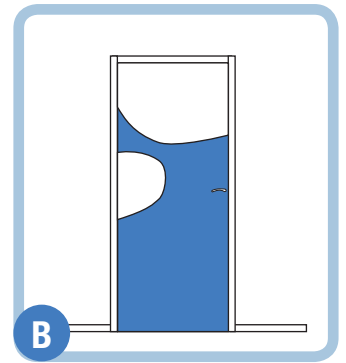

B

Feature rail  
FR 225

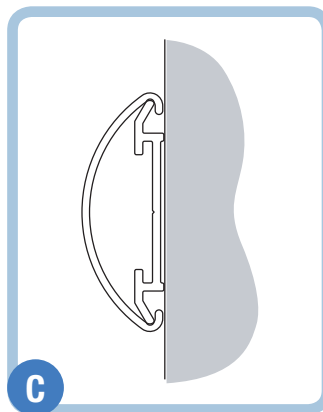

C

Surface Mounted  
Corner guard  
SSM 20  
C/S Acrovyn® Faux Wood

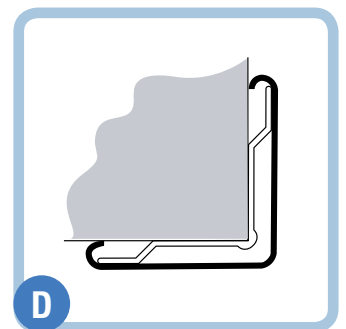

D



# Logistical centres

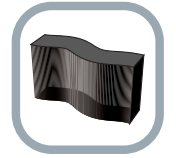

Elastomer

Heavy Duty protection,  
C/S Stelatex® is the range that  
suits all areas handling heavy loads.

**C/S Stelatex® Fender  
100 D**

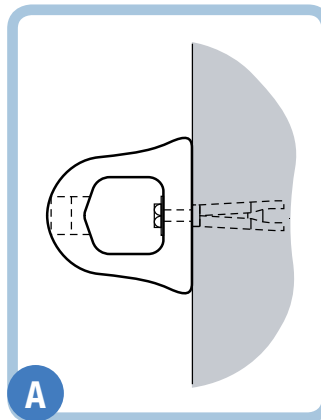

A

**C/S Stelatex® Rubber  
Bumper guard  
200 W 50**

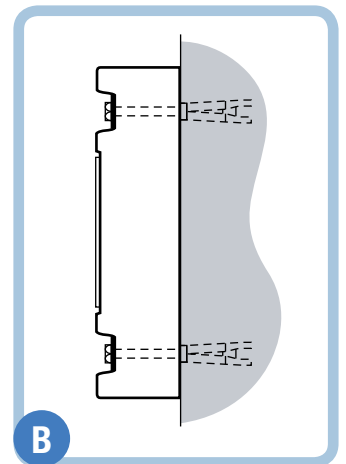

B

**C/S Stelatex® Rubber  
Corner guard  
100 C**

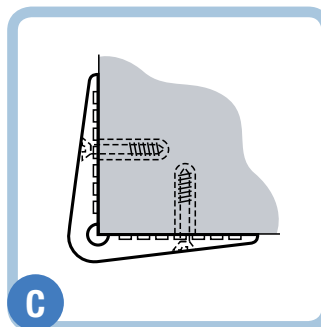

C

54687	ISTANBUL	7	12:27
45681	BRUSSELS	15	12:48
45681	VIENNA	6	13:02

A



# Transport interchanges



**C/S Acrovyn® 3000**  
**8 colours**

Our products, both functional and aesthetic, fit into the architectural design, underline it and make it durable.

**C/S Acrovyn® sheet**  
**C/S Acrovyn® 3000**

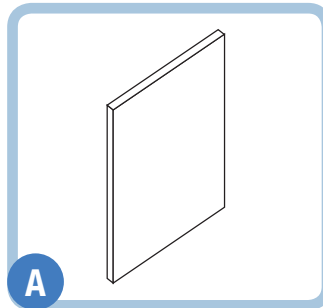

**A**

**Low Level Rail**  
**Stainless steel**  
**LLR-SS**

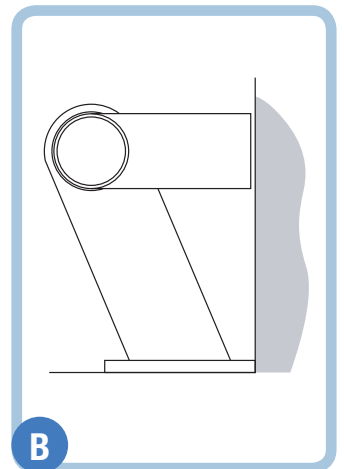

**B**

# The geographical presence...







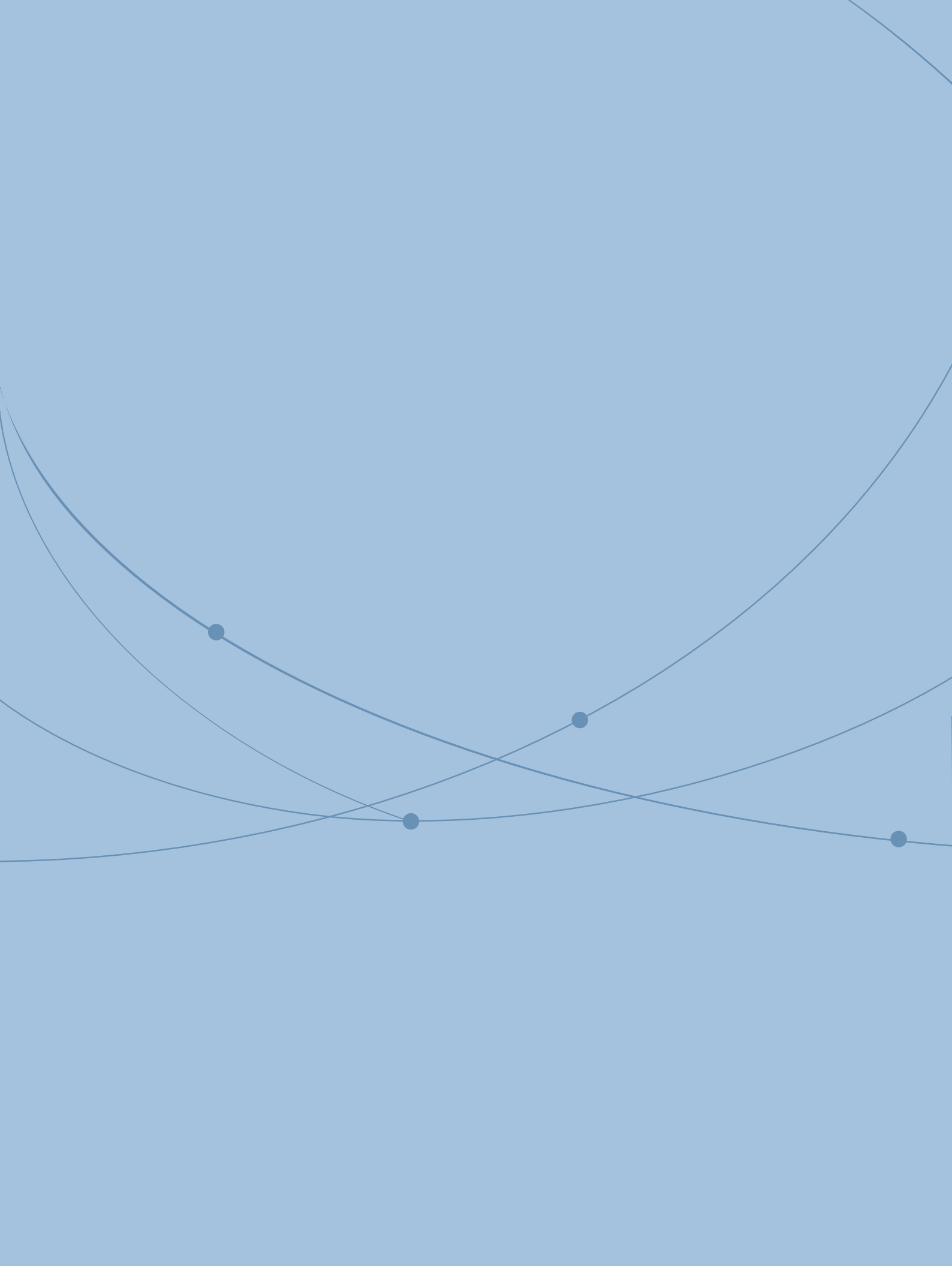

# ACRO ITEMS™

Everything you should know about our products

Detailed list of our products  
and all their characteristics



## PERFORMANCE OF C/S ACROVYN® SHEETS

### ■ Fire resistant

- Self-extinguishing
- acc. to Euroclasse EN 13501-EN with test result B – s2 – dO



### ■ Impact resistance

- Outstanding resistance: capable of resisting a load of 250 kg projected at a speed of 5 kmh!



### ■ Hygiene: non porous structure

- Prevents the development of bacteria
- Fast and easy to clean

Disinfection and cleaning certification delivered by the Institute of Hygiene and Preventive Medicine of University Louis Pasteur.



## TEXTURES AND COLOURS

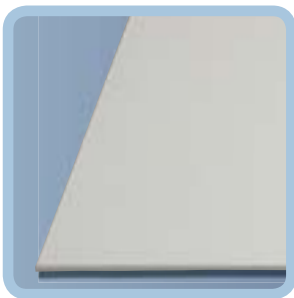

Textured



Smooth

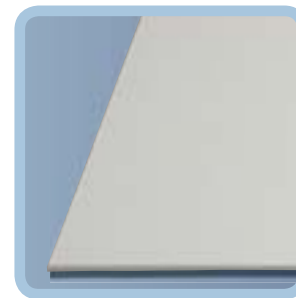

Textured

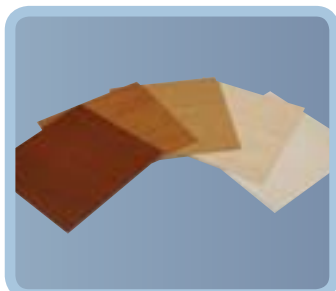

Smooth - 5 Woodgrains

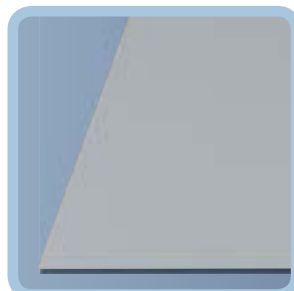

Smooth

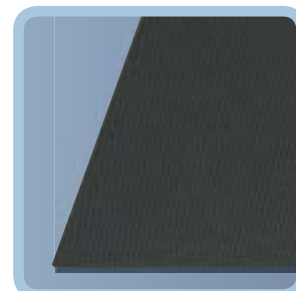

Smooth



FULL SIZED SHEETS

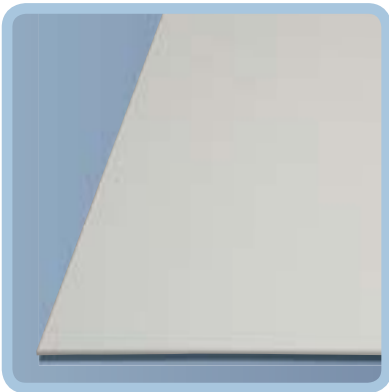

**C/S Acrovyn® sheet  
2 mm Textured**

3000 X 1300 mm



Fire certification



C/S Acrovyn®  
Solid Standard  
Colours



**C/S Acrovyn® sheet  
2 mm Smooth**

3000 X 1300 mm



Fire certification



C/S Acrovyn®  
Solid Standard  
Colours

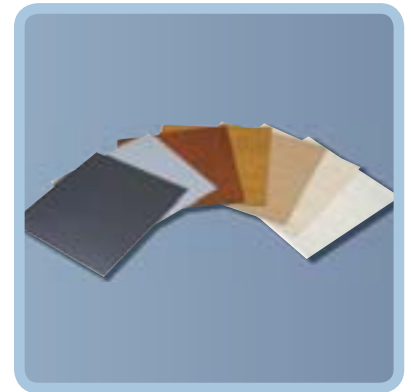

**C/S Acrovyn® sheet  
2 mm Smooth**

3000 X 1250 mm



Fire certification



C/S Acrovyn®  
Faux Wood



C/S Acrovyn®  
Faux Brushed  
Silver



C/S Acrovyn®  
Faux Carbon

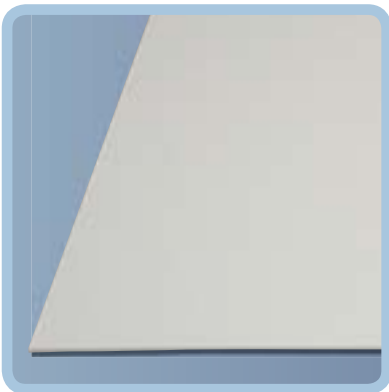

**C/S Acrovyn® sheet  
1.5 mm Textured**

3000 X 1300 mm



Fire certification



C/S Acrovyn® 3000  
8 colours



Smoke  
certification

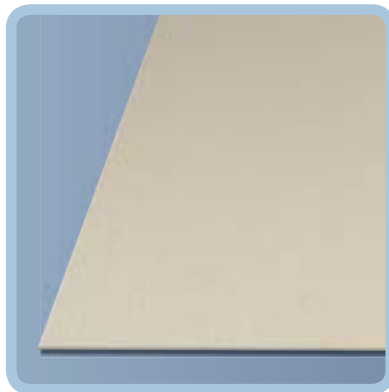

**C/S Acrovyn® sheet  
0.8 mm Textured**

3000 X 1300 mm



Fire certification



C/S Acrovyn®  
Solid Standard  
Colours



## CUT TO SIZE SHEETS

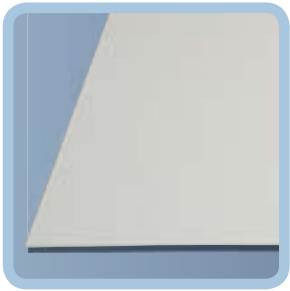

**C/S Acrovyn® sheet  
2 mm Textured**



Fire certification



C/S Acrovyn®  
Solid Standard  
Colours



**C/S Acrovyn® sheet  
2 mm Smooth**



Fire certification



C/S Acrovyn®  
Solid Standard  
Colours

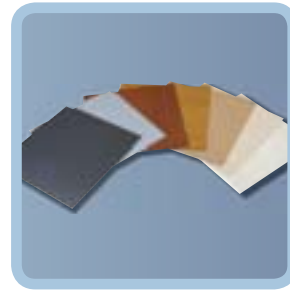

**C/S Acrovyn® sheet  
2 mm Smooth**



Fire certification



C/S Acrovyn®  
Faux Wood



C/S Acrovyn®  
Faux Brushed



C/S Acrovyn®  
Faux Carbon

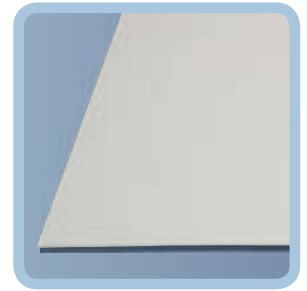

**C/S Acrovyn® sheet  
1.5 mm Textured**



Fire certification



C/S Acrovyn® 3000  
8 colours



Smoke  
certification



Examples of standard wall and door applications:

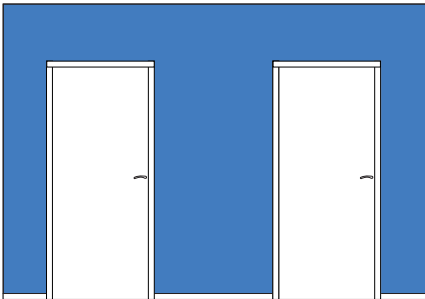

Full height

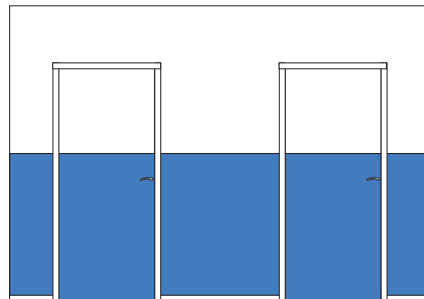

Mid-wall height 1300 mm

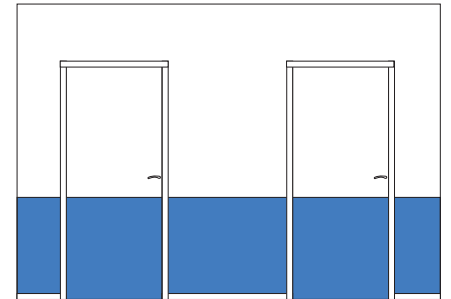

Mid-wall height 900 mm

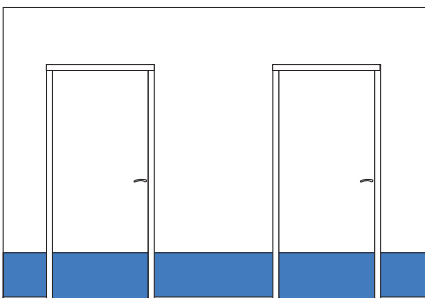

Height 430 mm

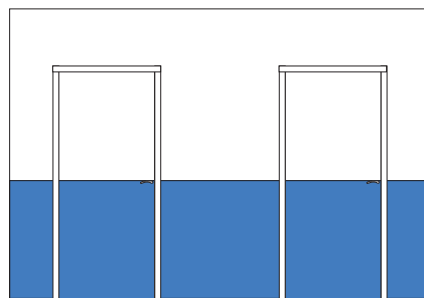

Customs height

Standard decorative wall protection shapes :

**ALIZÉ wave**

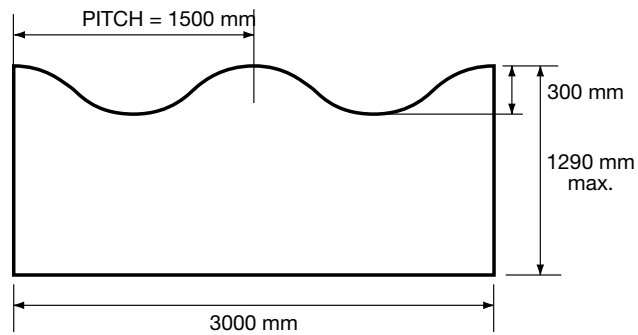

**SIROCCO wave**

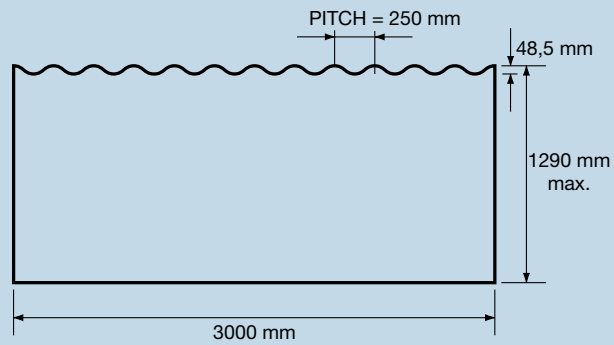

**MISTRAL wave**

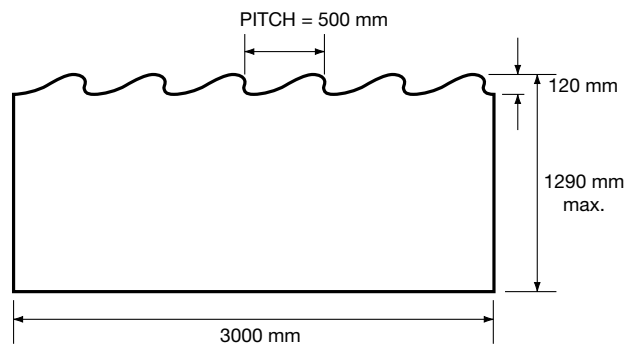

**TRAMONTANE wave**

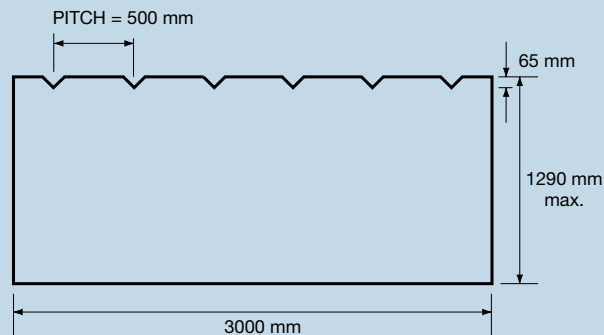

## Standard decorative door protection shapes

### C/S Acrovyn® decorative partial height cladding :

**WAVE**

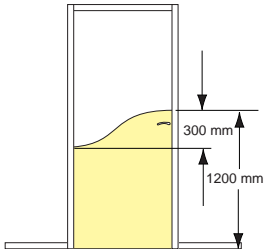

**DUNE**

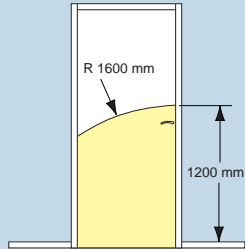

**STORM**

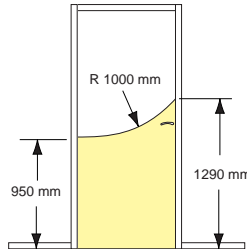

**OASIS**

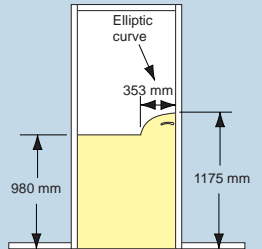

**PRAIRIE**

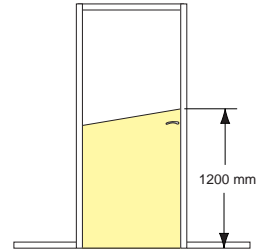

**HILL**

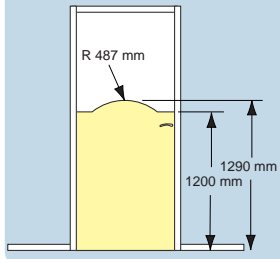

**VALLEY**

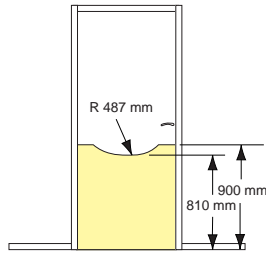

**CANYON**

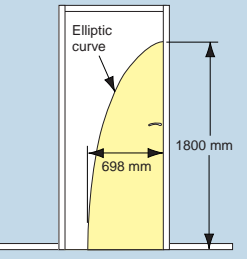

**PEAK**

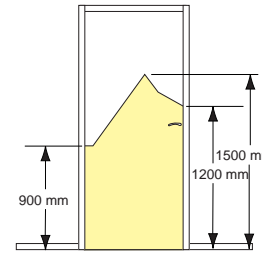

### Kick plate and push plate :

**CASCADE**

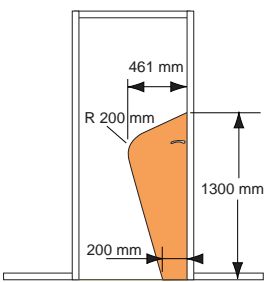

**LOW**

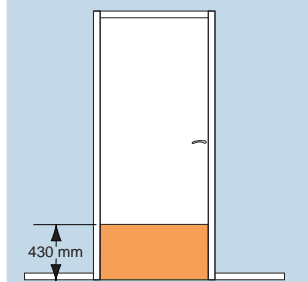

**RAINBOW**

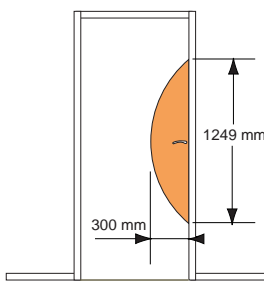

**RAINBOW with strip**

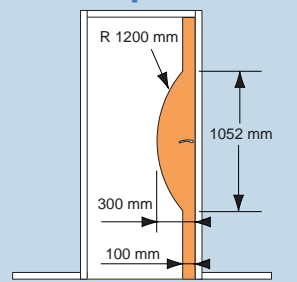

**HORIZON**

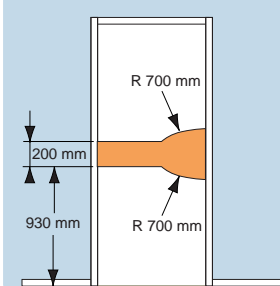

**TRIANGLE**

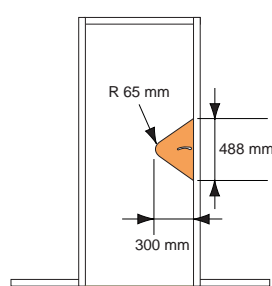

**QUARTER MOON**

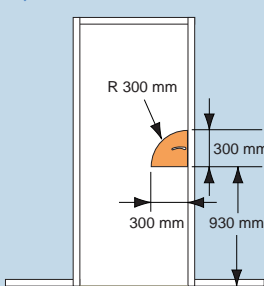

**HALF MOON 300/400/500 mm**

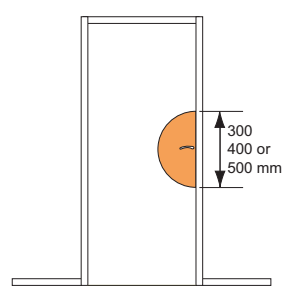

## FREE CREATIVE PATTERNS

### Create your own designs

All designs featured in the ACRO SPACE™ section can be produced using our advanced cutting technology.

**Please supply your designs in dxf format** and we will fabricate them for you. If you need any help with creating your designs call our Customer Service Team.

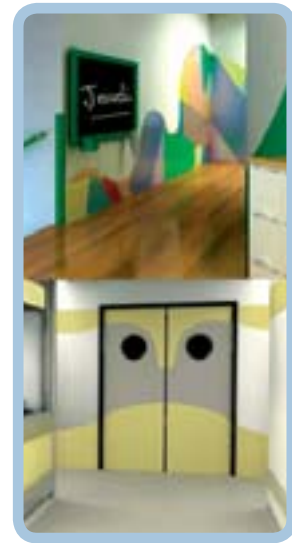
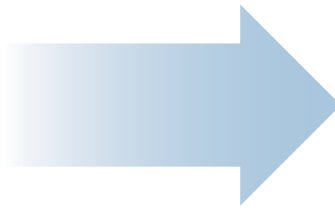

## CUSTOMIZED SIGNPOSTING





## FORMING

### Thermoforming



Thermoforming

#### Thermoforming L



#### Edge bevelling 45° on 2-mm sheet

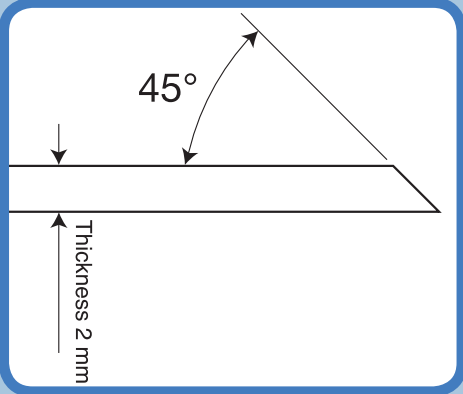

### Postforming



Custom-made thermoforming

#### L-shaped angle thermoforming "1 fold from 45 to 179°"

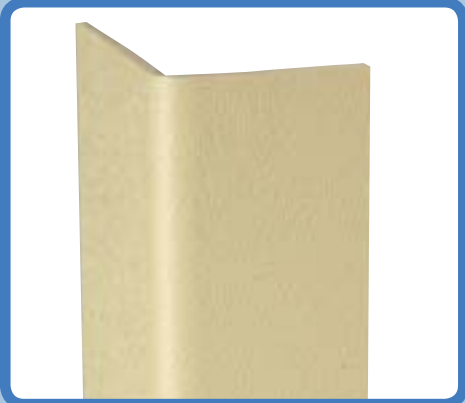

#### U-shaped channel thermoforming "2 folds"



## WALL APPLICATIONS



For locations subject to strict hygienic regulations, a 2 mm gap between sheets forming an expansion joint shall be filled with supple materials such as silicone mastic or welding rod.



Precoloured silicone



Welding rod

### Specific points for perfect hygiene:

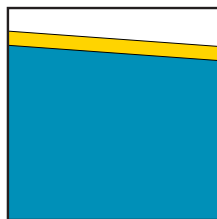

Silicone mastic seal

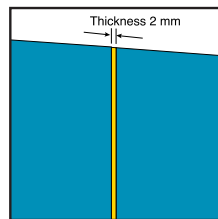

Welding between sheets

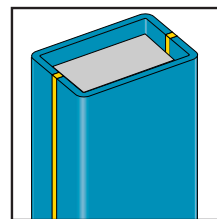

Pillar protection

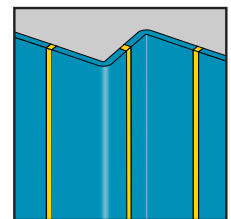

Junction between external and internal angle

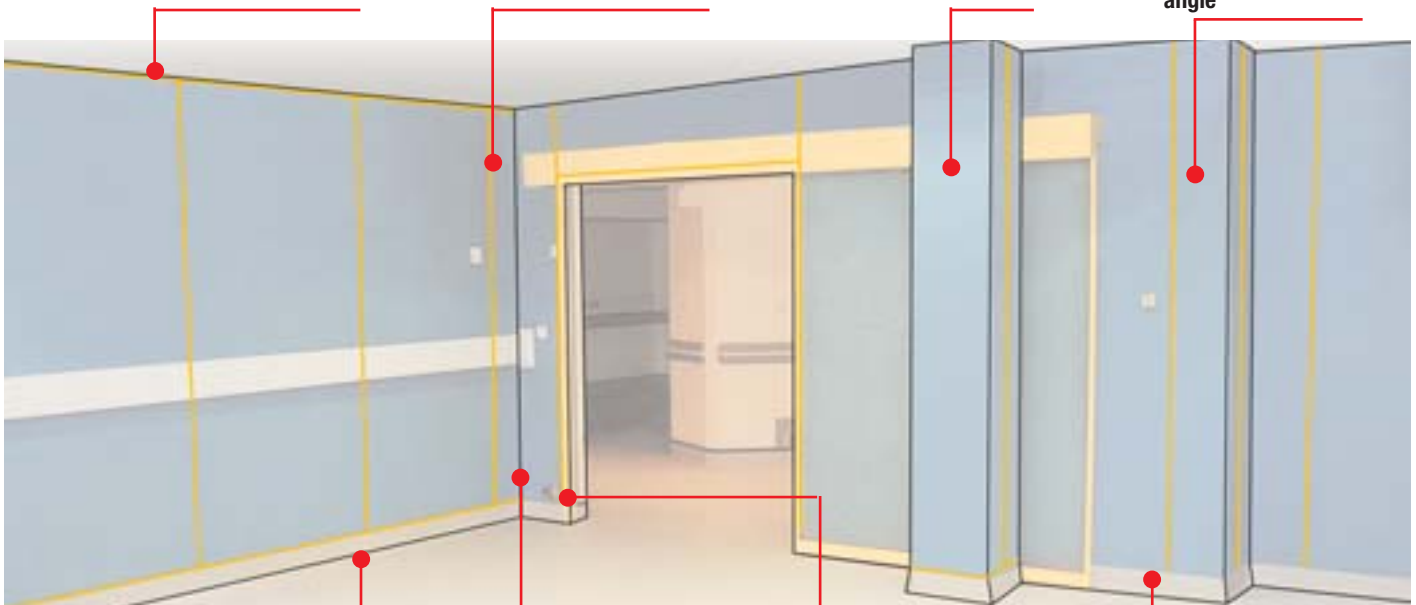

C/S Acrovyn® plinth  
H = 100 mm



Radiused internal angle thermoformed

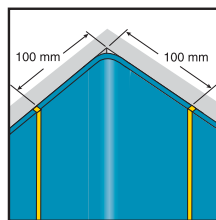

Door frame protection

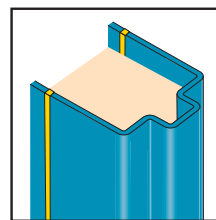

Heat-sealed junction with flexible flooring

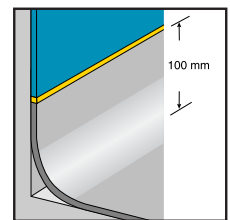

## DOOR APPLICATIONS

### SIMPLE PROTECTION

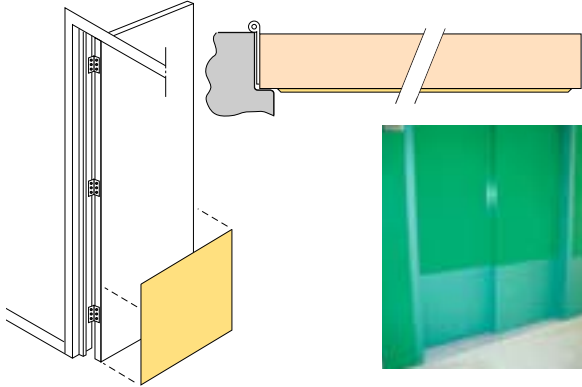

This is the **SIMPLEST** and **EASIEST** application case.

### 2 L-THERMOFORMED PARTS

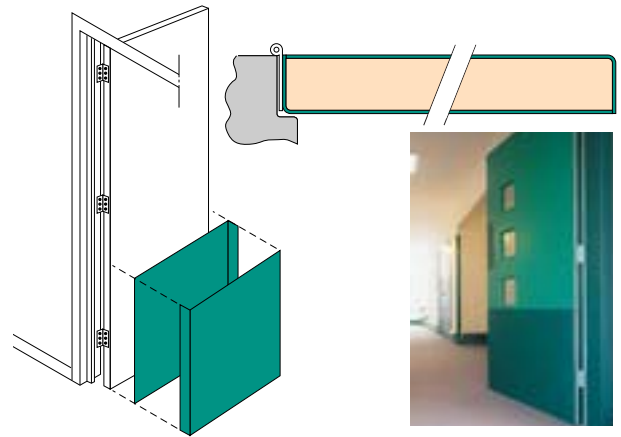

The protection is made in 2 L-angled thermoformed parts.  
**The door edges are perfectly protected.**

### ADD-ON U-PIECE AND SHEETS

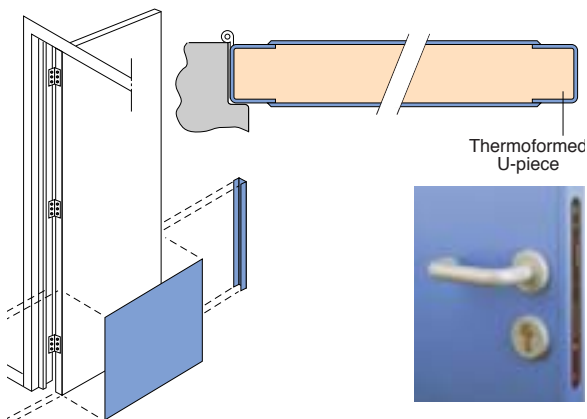

**This is the model suitable for the most abused surfaces.**

The door edges are protected by a U- thermoformed profile. Both door faces are covered with cut-to-size sheets with bevelled edges.

Note: Door edges should be rebated by the corresponding thickness of the C/S Acrovyn® sheet (2 mm thickness).

### SPECIAL FOR MOIST LOCATIONS (in this case, use glue M500)

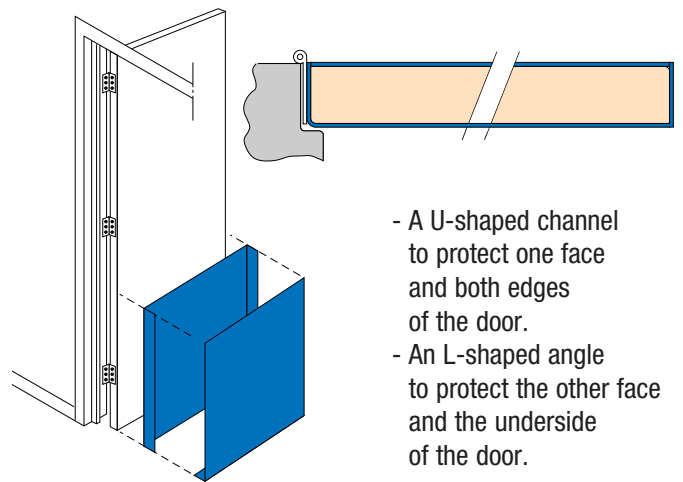

- A U-shaped channel to protect one face and both edges of the door.
- An L-shaped angle to protect the other face and the underside of the door.

### PROTECTION OF DOOR FRAMES

Door rebates and frames can also be protected by one-piece, postformed or thermoformed C/S Acrovyn® sheets cut to the exact dimensions of wood or metal frames.

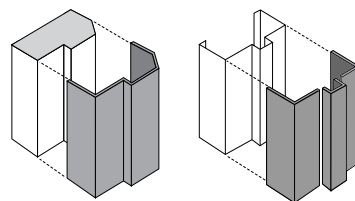

## INSTALLATION ACCESSORIES:



### UZIN PE 360 Primer

To be applied to absorbent surfaces (coverage usage : 0.15 kg/m<sup>2</sup>)



### UZIN KE 2000 S water based glue

Single-sided adhesive (coverage usage : 0.35 kg/m<sup>2</sup>). Odourless, for absorbent surfaces

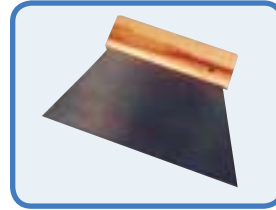

### Spreader

tooth A2  
1 for 100 m<sup>2</sup>



### EMFI 695 glue cleaner

Cleaning of tools and primer application (0.08 l/m<sup>2</sup> thinner + 0.08 l of adhesive)



### EMFI Gelcoat glue

Double-sided adhesive (coverage : 0.33 l/m<sup>2</sup>)



### OTTOCOLL TopFix

cartridge 300 ml for absorbent surfaces

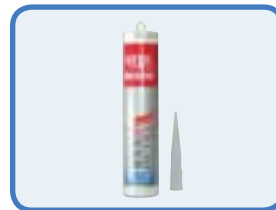

### OTTOCOLL M500

cartridge 300 ml, specially for moist locations, for non-absorbent surfaces

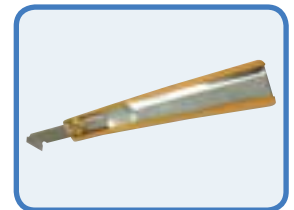

### Craft knife

for C/S Acrovyn® sheets

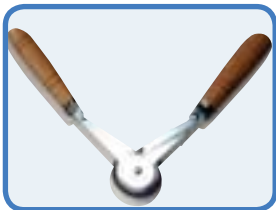

### Crane roller

With two articulated grips

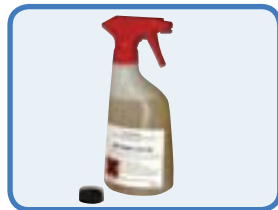

### Paint remover AGS 560

Spray



### Welding equipment

Complete kit

## FINISHING ACCESSORIES:



### C/S Acrovyn® plinth CB 100

- Standard length: 3.70 m
- Height: 100 mm with flexible lip
- **6 colours available:**  
Eggshell 100 / French Cream 101  
Pearl Grey 136 / Charcoal Grey 162  
Mocha 105 / Wedgewood Blue 111.



### Upper finishing trim

- 30 Standard colours
- Standard length: 3 m



### Vertical trim

- 30 Standard colours
- Standard length: 3 m



### Welding rod

- For sheet thickness 1.5 to 2 mm
- Roll 100 m
- 30 Standard Solid C/S Acrovyn® colours,
- **C/S Acrovyn® 3000**,  
2 colours available:  
Snow White 9003  
Dove Grey 24

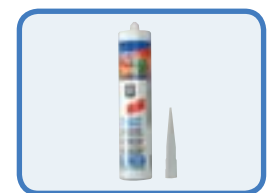

### Precoloured silicone

- Cartridge: 300 ml
- 30 Standard colours

# Handrails / Bumper guards



## HRB 20

Profile length: 4 m.

Mounting accessories:

- Mounting bracket
- Standard end cap and external corners, 135° corners
- Splice plate
- Removable kit for service duct
- Quick Install spanners

See photo page 24

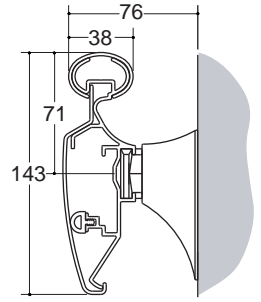

## HRB 35

Profile length: 4 m.

Mounting accessories:

- Mounting bracket
- Standard end cap and external corners, 135° corners
- Splice plate
- Removable kit for service duct
- Quick Install spanners

See photo page 22

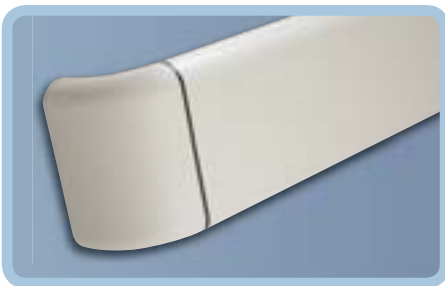
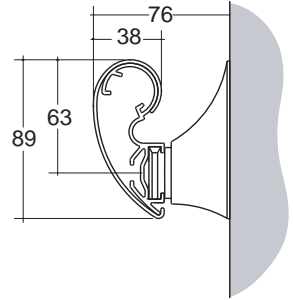

## HRB 4C

Profile length: 4 m.

Mounting accessories:

- Mounting bracket
- Standard end cap and external corners, 135° corners
- Splice plate

See photo page 30

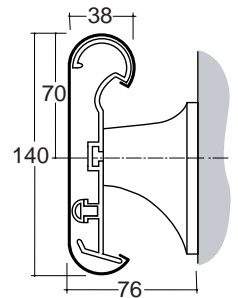

## ECR 32 A

Prefabricated ready-to-install kit.

Mounting accessories:

- Mounting bracket
- Standard end

See photo pages 44 and 46

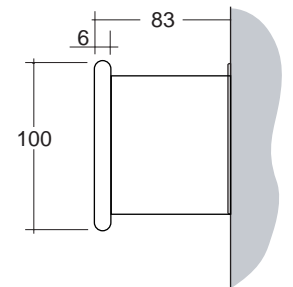

## HRB 35 A

Profile length: 4 m.

Mounting accessories:

- Mounting bracket
- Standard end cap and external corners, 135° corners
- Splice plate
- Removable kit for service duct
- Quick Install spanners
- Decorative contrasts strip 30 colours

See photo page 32

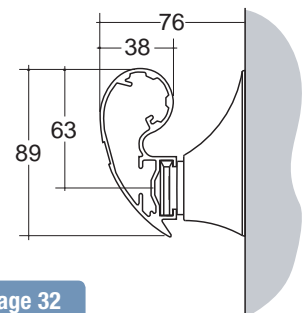

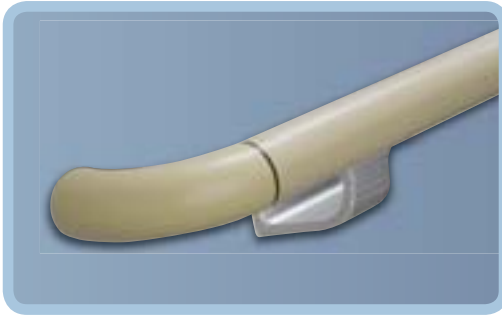

## MCE 40/45

Profile length: 4 m.

Mounting accessories:

- Aluminium or C/S Acrovyn® mounting brackets
- Standard end cap and external corners, 135° corners
- Splice plate
- Removable kit for service duct



Fire certification



C/S Acrovyn® Solid Standard Colours

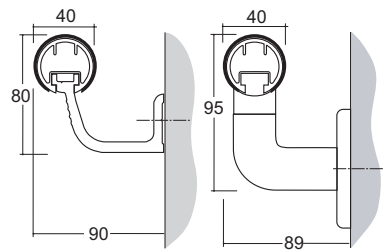

See photo pages 20

## MCE 40/45 A Aluminium

Profile length: 4 m.

Mounting accessories:

- Aluminium mounting bracket
- Standard end cap and external corners, 135° corners
- Splice plate
- Removable kit for service duct



Silver anodized

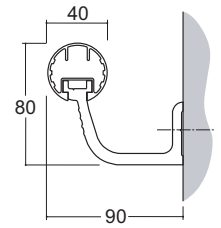
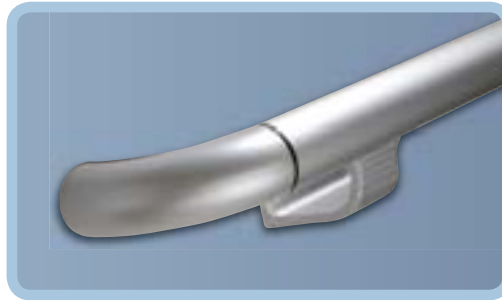

See photo pages 32



## VISION

Profile length: 4 m.

Available in a choice of 5 translucent colours

Mounting accessories:

- Polished aluminium mounting bracket
- Standard end cap and external corners, 135° corners
- Splice plate
- Removable kit for service duct



Fire certification

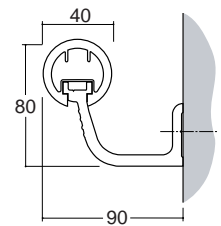

See photo pages 34 and 38

## HR 06

Profile length: 4 m.

Mounting accessories:

- Aluminium or C/S Acrovyn® mounting brackets
- Standard end cap and external corners, 135° corners
- Splice plate
- Removable kit for service duct

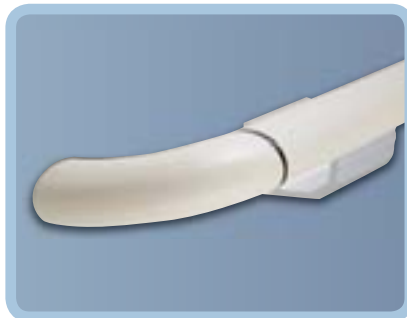

Fire certification



C/S Acrovyn® Solid Standard Colours



C/S Acrovyn® 3000 8 colours



Smoke certification



C/S Acrovyn® Faux Wood



C/S Acrovyn® Faux Brushed Silver



C/S Acrovyn® Faux Carbon

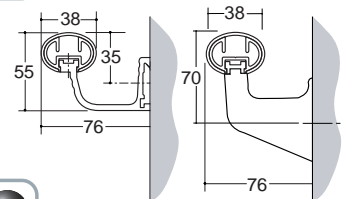

See photo page 42



## MCW 40/45

Profile length: 2 m

Prefabricated ready-to-install kit.

Mounting accessories:

- Stainless steel or C/S Acrovyn® mounting bracket
- Standard end cap and external corners, 135° corners
- Splice plate
- Removable kit for service duct



Wood Beech

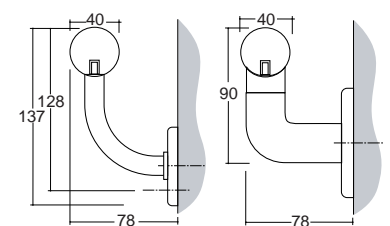

See photo page 36

# Crash rails

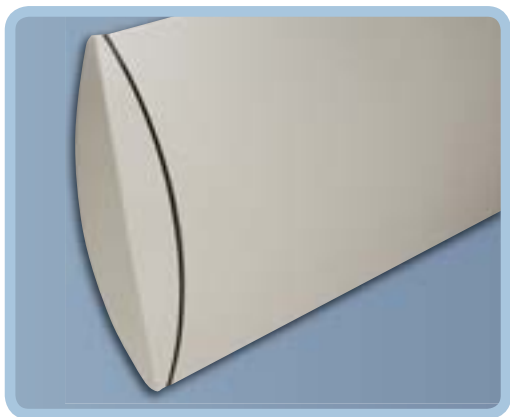

## SCR 80M

Profile length: 4 m.

Available in 2 versions:

- SCR 80M with continuous aluminium retainer

- SCR 80, Economic version with aluminium mounting brackets at 600 mm centres

Mounting accessories:

- Standard end cap, external corner
- Splice plate



See photo pages 24 and 42

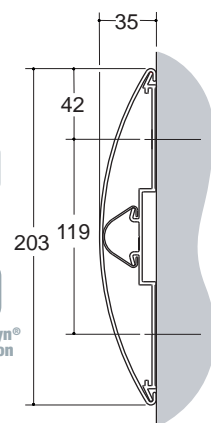

## SCR 50M

Profile length: 4 m.

Available in 2 versions:

- SCR 50M with continuous aluminium retainer

- SCR 50, Economic version with aluminium mounting brackets at 600 mm centres

Mounting accessories:

- Standard end cap, external corner
- Splice plate

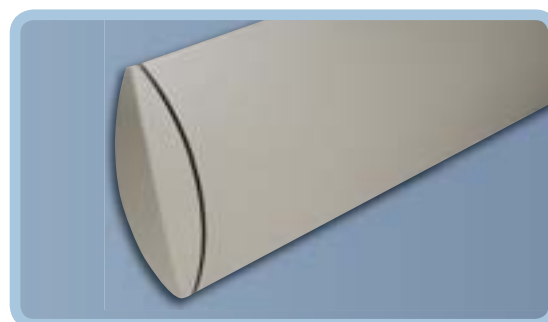

See photo page 30

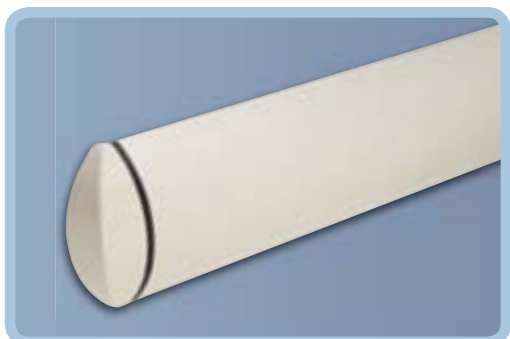
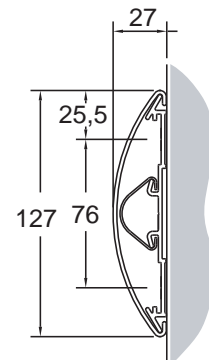

## FR 225

Profile length: 4 m.

with continuous aluminium retainer

Mounting accessories:

- Standard end cap, external corner



See photo pages 30, 46 and 48

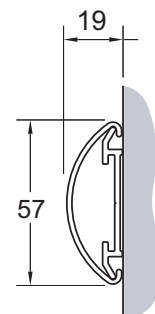

## ARONDE 170

Profile length: 4 m.

Available in 2 versions:

- ARONDE 170, with continuous vinyl bumper rail and aluminium mounting brackets at 600 mm centres

- ARONDE 170 E, Economic version, mounted with aluminium mounting brackets only at 600 mm centres

Mounting accessories:

- Standard end cap, external corner
- Splice plate
- Decorative contrast strip in 30 colours

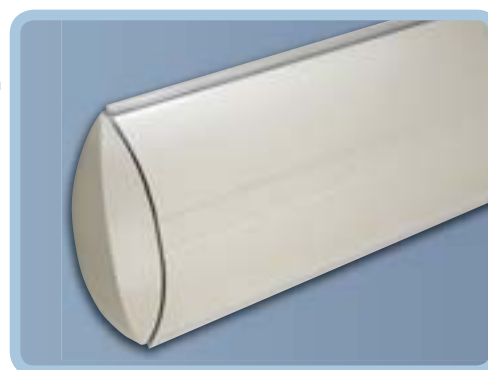
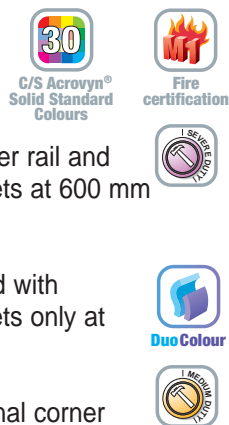

See photo pages 40 and 44

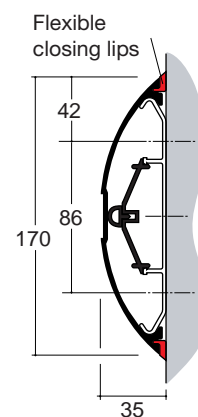

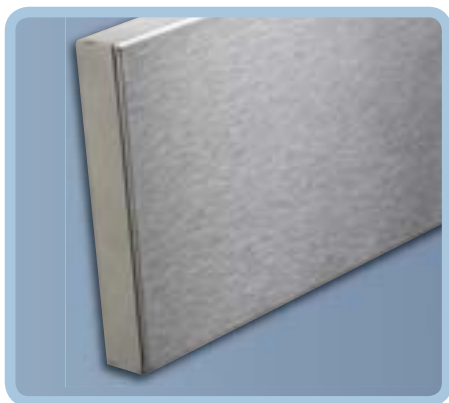

## CRS 200

Prefabricated ready-to-install kit, 3 m max., with upper and lower, pre-drilled mounting strips.  
 Cover : thickness 1.2 mm  
 Food-approved, brushed stainless steel (304 L).  
 Closed prefabricated welded end caps.

See photo page 40

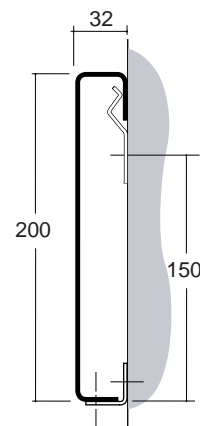

## CRS 150

Prefabricated ready-to-install kit, 3 m max., with upper and lower, pre-drilled mounting strips.  
 Cover : thickness 1.2 mm  
 Food-approved, brushed stainless steel (304 L).  
 Closed prefabricated welded end caps.

See photo page 40



Brushed stainless steel

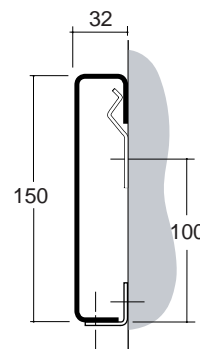
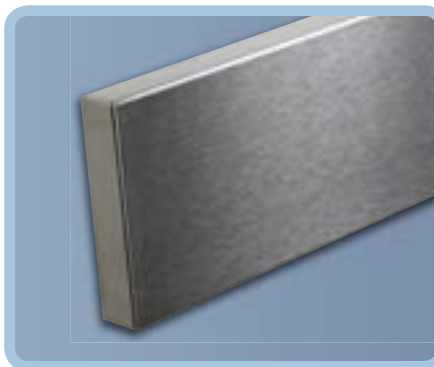

## CRS 100

Prefabricated ready-to-install kit, 3 m max., with upper and lower, pre-drilled mounting strips.  
 Cover : thickness 1.2 mm  
 Food-approved, brushed stainless steel (304 L).  
 Closed prefabricated welded end caps.

See photo page 40



Brushed stainless steel

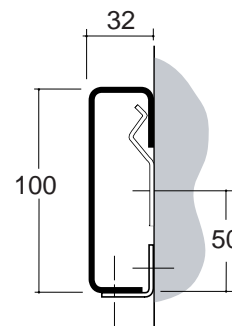

## LLR-SS

Profile length: 3 m.  
 Food-approved, polished stainless steel (304 L).

Mounting accessories:

- Stainless steel mounting bracket with base plate
- Standard, external or internal end caps
- Splice plate

See photo pages 46 and 52



Polished stainless steel

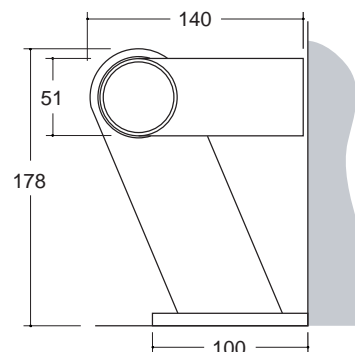



# Trolley Plates

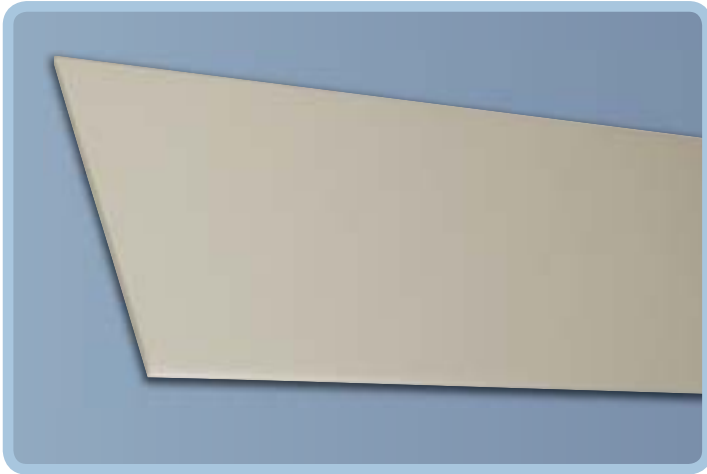

## TP 300/200/150/100

Profile length: 4 m.

● TP 300 / 200 / 150 / 100  
C/S Acrovyn® only.

Complementary accessories:

■ External or internal corner 200 x 200 mm



Fire certification



C/S Acrovyn®  
Solid Standard  
Colours



See photo pages 20 and 22

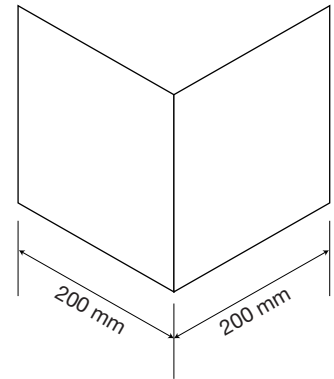
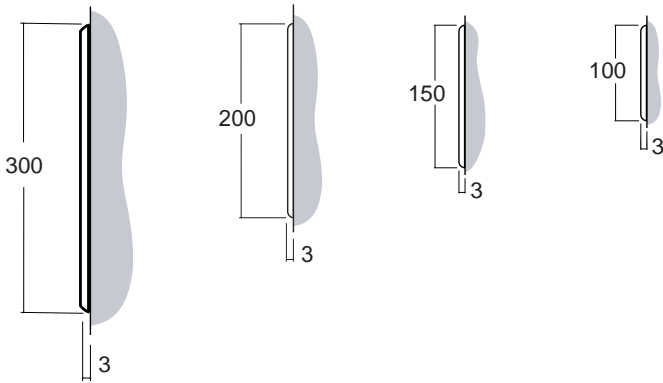

External or internal corner

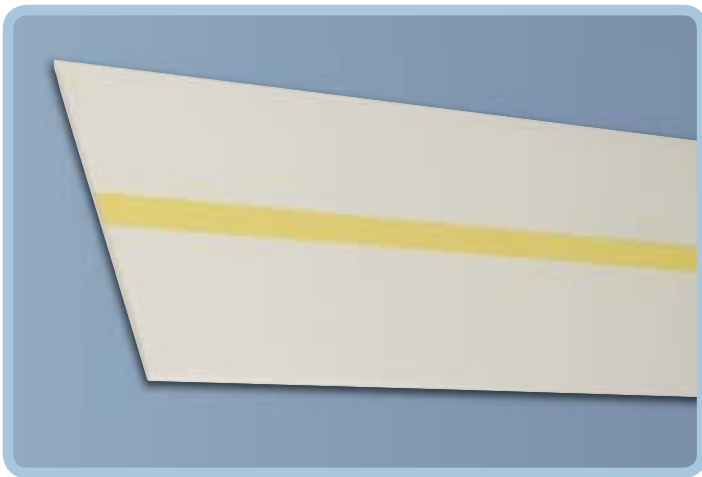

## TP 200 DUO

Profile length: 4 m.

● TP 200 DUO  
C/S Acrovyn® only.

Complementary accessories:

■ External or internal corner 200 x 200 mm



Fire certification



Duo Colour



See photo page 26

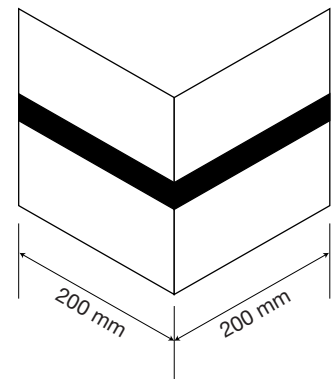
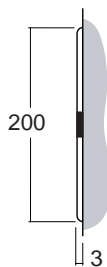

External or internal corner

# Surface mounted and stick on corner guards

## Surface mounted corner guards

### SM 20

Profile length: 3 m.

Accessory:

- End cap



See photo page 46

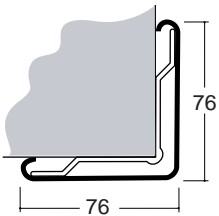

### SSM 20

Profile length: 3 m.

Accessory:

- End cap



C/S Acrovyn® Faux Wood C/S Acrovyn® Faux Brushed C/S Acrovyn® Faux Carbon

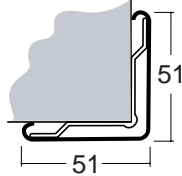

### SM 20 M

Profile length: 3 m.

Accessory:

- End cap

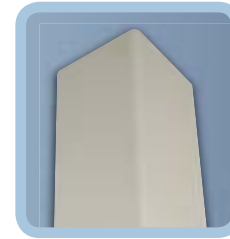

See photo pages 24 and 32

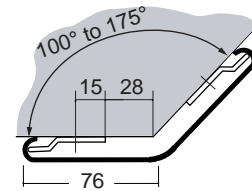

## Stick-on corner guards

### SO 75/50/30

Profile length: 3 m.

- SO 75/50/30 C/S Acrovyn® only.

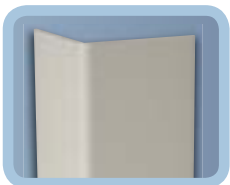

See photo page 22

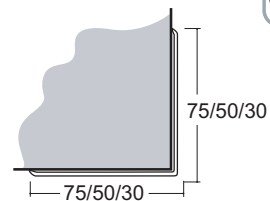

### 50A/40A/30A

Profile length: 3 m.

- Self-adhesive. Thickness 1 mm Food-approved, brushed stainless steel (304 L).

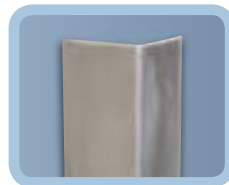

See photo page 40

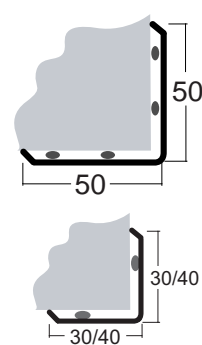

### SO 50 V DUO

Profile length: 3 m.

- SO 50 V DUO C/S Acrovyn® only.

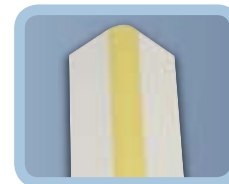

See photo page 26

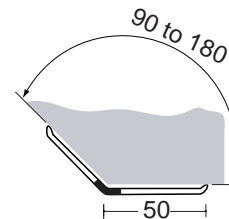

### SO 50 V

Profile length: 3 m.

- SO 50 V C/S Acrovyn® only.

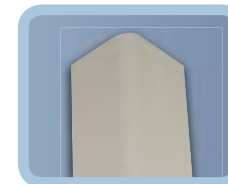

See photo pages 20 and 22

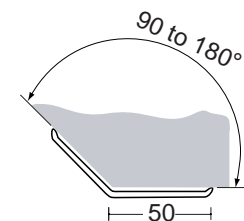

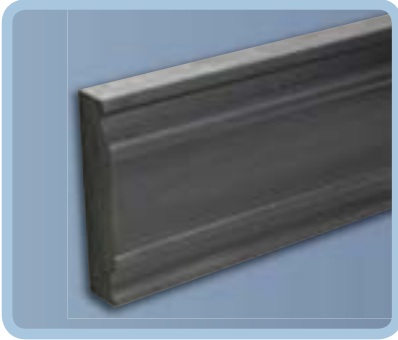

## 200 W 50

Profile length: 3 m.

Optional:  
Self-adhesive reflective insert.



Elastomer

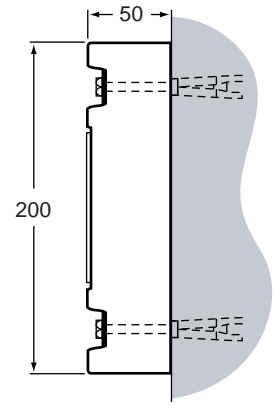

See photo page 50

## 200 W 30

Profile length: 3 m.

Optional:  
Self-adhesive reflective insert.



Elastomer

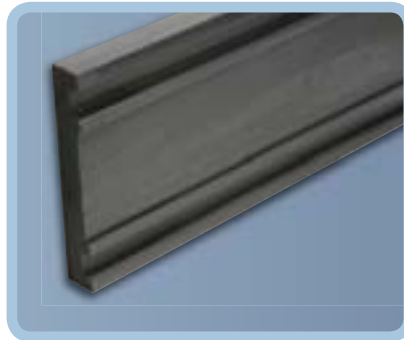

See photo page 50

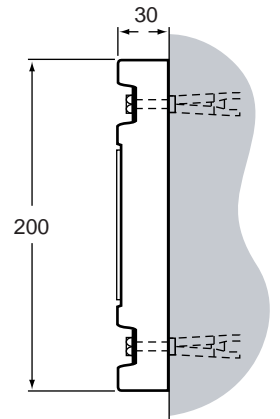

## 150 W 20

Profile length: 3 m.

Supplied with aluminium fastening strip  
and closing gasket



Elastomer

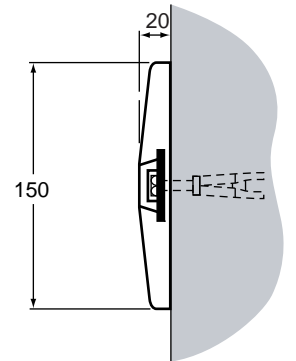

See photo page 50

## 100 D

Profile length: 3 m.

Accessories:

- Closing piece
- Screw cap



Elastomer

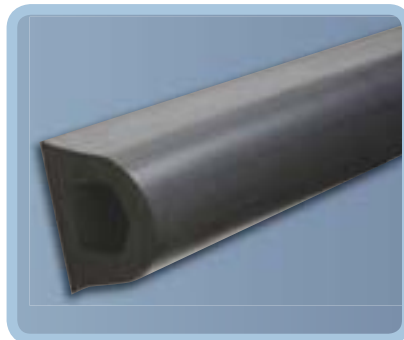

See photo page 50

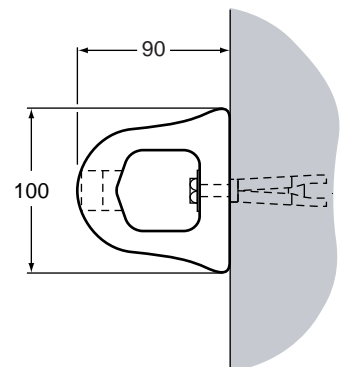

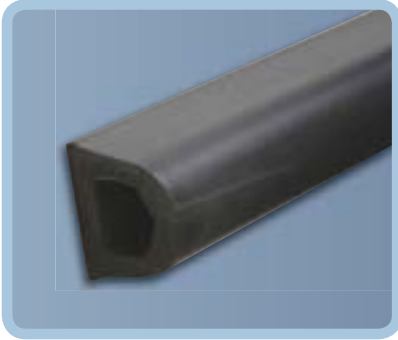

## 75 D

Profile length: 3 m.

Accessories:

- Closing piece
- Screw cap



Elastomer

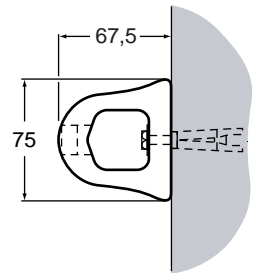

See photo page 50

## 60 B

Profile length: 3 m.

Supplied with aluminium fastening strip.



Elastomer

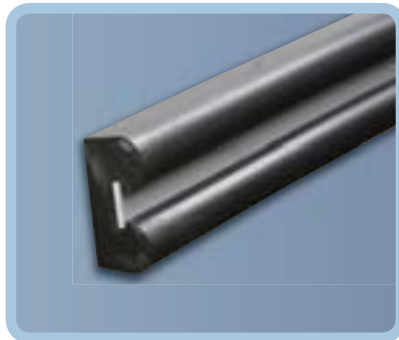

See photo page 50

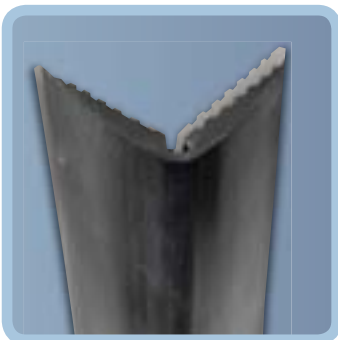
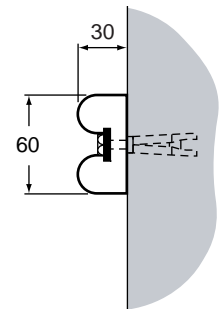

## Corner guards 100 C

Profile length: 3 m.



Elastomer

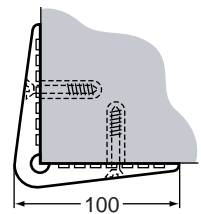

See photo page 50

## Corner guards 75 C

Profile length: 3 m.



Elastomer

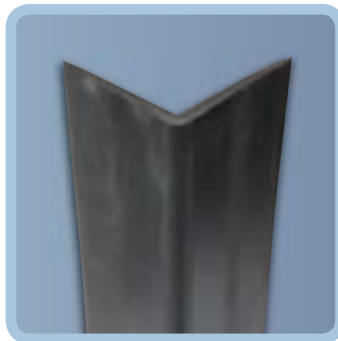

See photo page 50

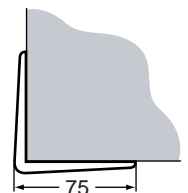





# ACRO SERVICES™

Installation advice, services and solutions

Our installation partners are available on site and will work with you from project design until its successful completion.



Our installation partners will work with you from the preliminary study until the final installation.



### **OUR TEAMS MAKE YOUR LIFE SIMPLER:**

Our Company representatives and installation partners provide you with expertise on the choice of products that meet your needs. Our sales representatives are also technically orientated, they are able to take the measurements on site and supply projects fully installed on a turn key basis.

### **TO HELP YOU SELECT THE RIGHT PRODUCT FOR YOUR PROJECT WE PROVIDE:**

- **Specification texts** providing the detailed description for each product. These are available in paper or electronic format, or downloadable from our website.
- **Colour selection charts and real product samples to confirm your choice.**
- **On-line product guide for the right choice of products and colour visualizer at HYPERLINK «<http://www.cs-france.fr>» [www.cs-france.fr](http://www.cs-france.fr) or HYPERLINK «<http://www.c-sgroup.com>» [www.c-sgroup.com](http://www.c-sgroup.com)**

**EXCLUSIVE**

The visualizer is an architectural framework which you can use to customize with product options and colours to create your own scheme.

Our colour designer suggests 24 typical colour schemes to guide you in your choice.

- **Colour selection cards for the choice of colours:  
Printed card with 6 colour scheme options.**

**C/S France is the leading Interior Wall Protection  
Manufacturer in Europe**

Even easier with...



**Manufacturer**

### SERVICE + : MANUFACTURER

*Our extrusion lines are at your service.*

Project related production at required lengths : (reduction of material waste).

- Minimum of 150 metres for a specific production at project lengths.
- Production / Supply time ex works : approximately 4 to 5 weeks.
- Production tolerances of 20 to 40 mm in excess length



**Cut  
to length**

### SERVICE + : CUTTING

*Our teams work for you.*

We cut the products to the required length.

- Tolerances: +/- 1 mm



**Quick install  
pre-fabrication**

### SERVICE + : QUICK INSTALL

*Delivery of prefabricated ready-to-install handrails.*

- Reduced installation time.
- No cutting on site.
- Keeps costs under control.





Our products are designed for easy and rapid fitting

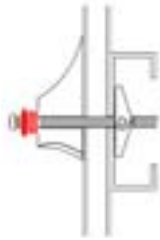

Fasten the mounting quick lock bracket to the wall.



Position the handrail on the lock of the mounting bracket. Just give the lock a quarter turn to fasten the handrail.

## DECISIVE ADVANTAGES FOR YOU!

### In your workshop:

- Cutting to length.
- Fitting of profiles and end caps without drilling, screwing or riveting operations.
- The mounting of the end caps simply by a quarter turn with a spanner.

### On site:

- Total freedom for the positioning of the mounting brackets on the wall.
- At the final phase of the installation, presentation of the pre-mounted elements and locking the quick lock mounting bracket by a mere quarter turn with a spanner.

### Benefits:

- Cost reduction for the installation teams, reduced travelling expenses.
- Time optimization = **SAVINGS !**
- Final product installation at the end after all finishing works
- No risk of damage. No cleaning.
- Wall maintenance made easy by rapid removal and fitting.



Mounting of the standard end cap



**Without Quick Install**  
2 installers

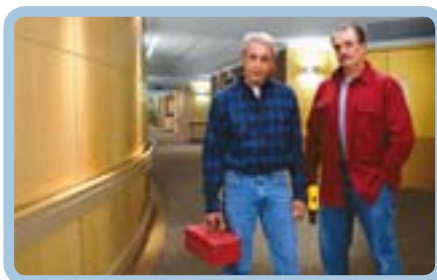

**With Quick Install**  
only 1 installer



**C/S FRANCE**  
**135, rue Edouard Isambard**  
**B.P. 66**  
**27120 Pacy-sur-Eure Cedex**  
**FRANCE**

Tel. : 00 33 (0)2 32 67 00 00

Fax : 00 33 (0)2 32 67 14 12

Website: [www.cs-france.fr](http://www.cs-france.fr)

[www.c-sgroup.com](http://www.c-sgroup.com)

E-mail: [marketing@cs-france.fr](mailto:marketing@cs-france.fr)

Local sales representation office

USA - CANADA - HONG-KONG - SINGAPORE - AUSTRALIA - EUROPE

**CS** Construction Specialties

worldwide

COUVRENEUF



Expansion joint covers systems

C/S ACROVYN®



Wall, corner and door protection

C/S PEDISYSTEMS



Entrance flooring systems

WATTOHM



Technical profiles and plastic tubes

WATTOLENE



Extruded polystyrene sheets

LUMISYSTEMS



Lighting appliances

C/S AIRFOIL



Sun controls

## MOBILITY AIDS - HANDRAILS

Handrails			
Ergonomic shape ▶	Textured		Smooth finish
	Shape of Now	Traditional	Hygienic
Material			
C/S Acrovyn Solid Colours	HRB 20 (p. 68)	HRB 4C (p. 68)	MCE 40/45 (p. 69)
	HRB 35 (p. 68)		
	HR 06 (p. 69)		
	Faux Wood HR 06 (p. 69)		
	Faux Brushed Silver HR 06 (p. 69)		
Other materials	C/S Acrovyn 3000 HRB 20 (p. 68)		
	HR 06 (p. 69)		
	Wood Beech HRB 20 (p. 68)	MCW 40/45 (p. 69)	
Silver anodized			ECR 32 A (p. 68) HRB 35 A (p. 68) MCE 40/45 A (p. 69)
Vision			Vision (p. 69)

## WALL PROTECTION PROFILES

Bumper guards			
Ergonomic shape ▶	Textured		Smooth finish
	Shape of Now	Traditional	Hygienic
Material			
C/S Acrovyn Solid Colours	SCR 80M (p. 70)	TP 300 (p. 72) TP 200 (p. 72) TP 150 (p. 72) TP 100 (p. 72)	ARONDE 170 (p. 70)
	SCR 50M (p. 70)		
	FR 225 (p. 70)		
	Faux Wood SCR 80M (p. 70)		
	Faux Brushed Silver SCR 80M (p. 70)		
Other materials	C/S Acrovyn 3000 SCR 80M (p. 70)		
	Stainless steel SCR 80M (p. 70)		
			CRS 200 (p. 71) CRS 150 (p. 71) CRS 100 (p. 71) LLR-SS (p. 71)

Corner guards			
Ergonomic shape ▶	Textured		Smooth finish
	Shape of Now	Traditional	Hygienic
Material			
C/S Acrovyn Solid Colours	Stick On	SM 20 (p. 73) SSM 20 (p. 73) SM 20M (p. 73)	Stick On
	SO 75 (p. 73)		
	SO 50 (p. 73)		
	SO 30 (p. 73)		
	SO 50V (p. 73)		
Other materials	Faux Wood SSM 20 (p. 73)		
	Faux Brushed Silver SSM 20 (p. 73)		
	C/S Acrovyn 3000 SSM 20 (p. 73)		
Stainless steel			50 A (p. 73) 40 A (p. 73) 30 A (p. 73)

### Protection and Design: C/S Acrovyn® sheets for Wall and Door Protection

Material	Thickness	Textured	Smooth finish
C/S Acrovyn Solid Colours	2 mm (p. 59 to 67)	30 colours	6 colours
	0.8 mm (p. 59 to 67)	30 colours	
	2 mm (p. 59 to 67)		5 Woodgrains
	2 mm (p. 59 to 67)		Brushed Silver
Other materials	2 mm (p. 59 to 67)		Carbon
	1.5 mm (p. 59 to 67)	8 colours	

## INDUSTRIAL PROTECTION

C/S Stelatex			
Material	Bumper guard	Corner guard	
Elastomer	EPDM		
		200 W 50 (p. 74)	
		200 W 30 (p. 74)	
		150 W 20 (p. 74)	
		100 D (p. 74)	
		75 D (p. 75)	
Neoprene		60 B (p. 75)	
			100 C (p. 75) 75 C (p. 75)

# THE STRENGTH OF A LEADER

**CS Construction Specialties**

**WORLD LEADER**

For several decades, Construction Specialties, Inc. has been pursuing its innovative approach by giving priority to quality and service.

Our leading position for over 50 years has nothing to do with luck.

It is the result of total commitment to our customers' satisfaction. The C/S Acrovyn® range is available on all continents.

**CS France**

**EUROPEAN LEADER**

How to protect walls against impacts?

How to match wall protection with global floor and global interior environment ?

How to ensure hygiene in exposed locations?

**QUESTIONS YOU HAVE TO FIND AN ANSWER TO EVERY DAY!**



ACRO SERVICES™

### EVERYTHING TO MAKE INSTALLATION EASIER

Required tools and adhesives are sold by the unit and are available from stock. Instructions are always attached to our products.

### WELL-PREPARED SHIPMENTS

Our project orders are individually prepared and our products are packaged in plastic film protected cardboard boxes.

Delivery on pallet upon request

**C/S FRANCE also means further architectural product solutions that you can discover on our websites: [www.cs-france.fr](http://www.cs-france.fr)**



E-MAIL : [marketing@cs-france.fr](mailto:marketing@cs-france.fr)

## Material and colour selection chart C/S ACROVYN®

### 30 C/S Acrovyn® Solid Standard Colours

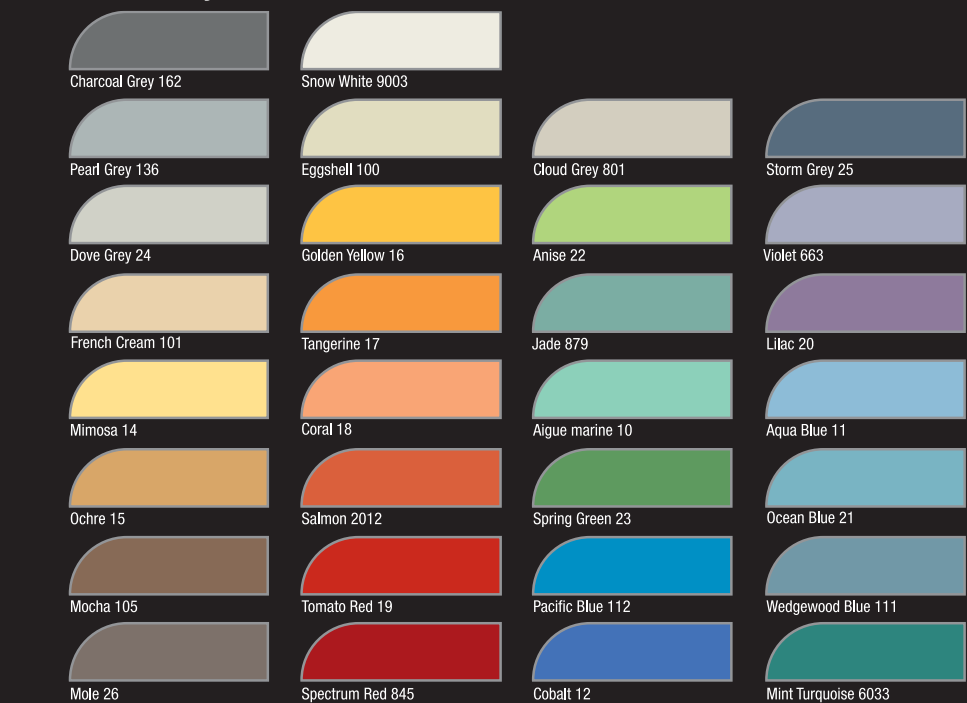

### 5 Standard Colours for the Vision Handrail



### 2 x 5 DUO Colour combinations

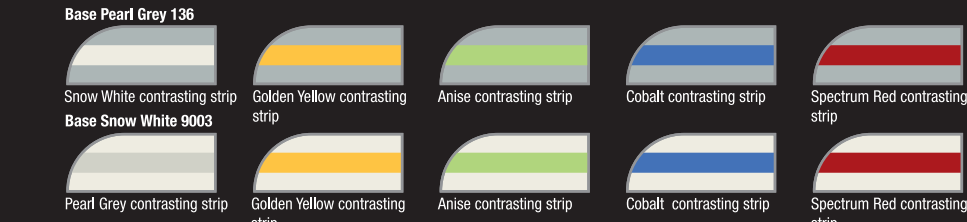

### 6 C/S Acrovyn® Solid Standard Colours for smooth hygienic sheets

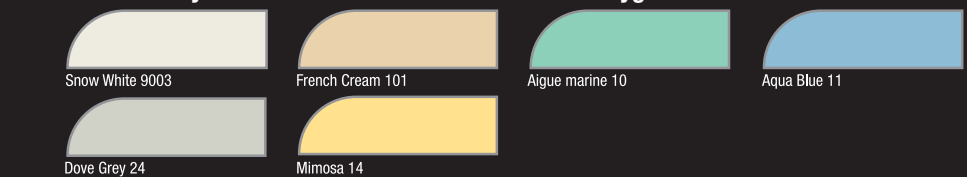

### 5 C/S Acrovyn® Faux Woodgrains



### C/S Acrovyn® Faux Brushed Silver C/S Acrovyn® Faux Carbon

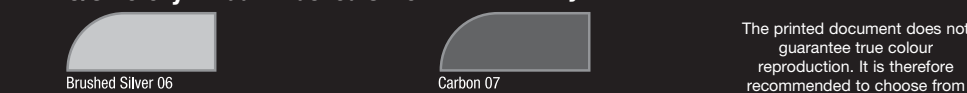

### 8 C/S Acrovyn® 3000 Standard Solid Colours

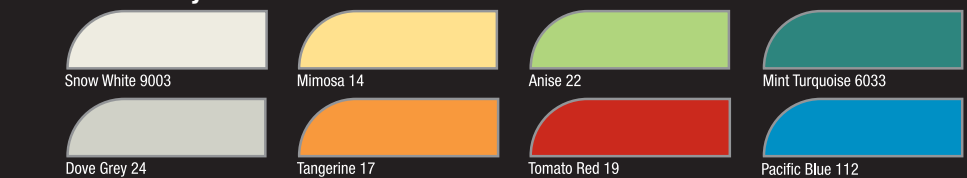

The printed document does not guarantee true colour reproduction. It is therefore recommended to choose from real product samples.